

Read all instructions BEFORE assembly and USE of product.  
KEEP INSTRUCTIONS FOR FUTURE USE.

## Stride Sport

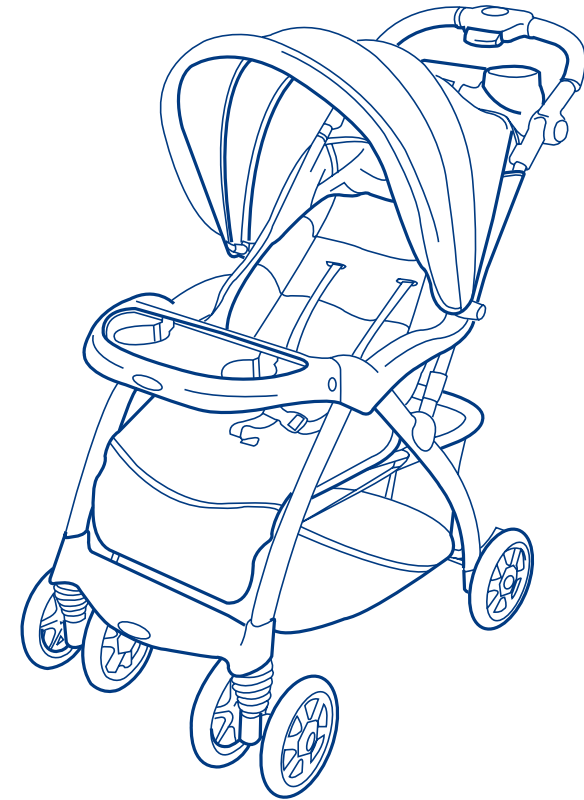

**baby trend**  
Convenience through innovation and thoughtful design

Contact us by mail:  
Baby Trend, Inc.  
1607 S. Campus Ave., Ontario, CA 91761

Contact us by phone:  
1-800-328-7363 (8:00am ~ 4:30pm PST)  
or online <http://www.babytrend.com>

Instruction Manual

**baby trend**  
Convenience through innovation and thoughtful design  
[www.babytrend.com](http://www.babytrend.com)

10.08

**⚠ WARNING:** Please follow all of these instructions to ensure the safety of your child. Keep these instructions for future reference.

**⚠ WARNING:** Failure to follow these instructions could result in serious injury or death. Avoid serious injury from falling or sliding out, always use the safety harness and insure that the children are properly positioned according to these instructions.

**⚠ WARNING:** Never leave children unattended.

- **CAUTION:** This stroller is designed for one child only. Use with more than one child may cause the unbalance condition which can injure/ harm your child.
- Purses, shopping bags, parcels, diaper bags or accessory items may change the balance of the stroller and cause a hazardous, unstable condition.
- The maximum weight that can be carried in the storage basket is 5 lbs. The maximum weight that can be carried in the Parent Tray and Child Tray is 3 lbs each. Excessive weight may cause a hazardous unstable condition to exist.
- Be certain the stroller is completely opened and locked in place before allowing a child near the stroller.
- The maximum weight capacity of this stroller is up to 45 pounds additional weight will cause excessive wear and stress on the stroller and may cause a hazardous unstable condition to exist.
- **NEVER** use the stroller on stairways or escalators.
- **NEVER** use the stroller with roller skates, in-line skates, skateboards or bicycles.
- **NEVER** allow your stroller to be used as a toy.
- To clean use only mild household soap or detergent and warm water on a sponge or clean cloth.
- Check your stroller for loose screws, worn parts, torn material or stitching on a regular basis. Replace or repair parts as needed.
- Discontinue use of stroller should it malfunction or become damaged. Please contact our customer service department to arrange for repair or obtain replacement parts.

*If you experience any difficulty with assembly, missing parts or use, please DO NOT return this item to the store. Retail stores are unable to properly assist you. Contact our Customer Service Department directly for assistance. Call toll-free 1-800-328-7363, Monday -Friday, between the hours of 8:30 a.m. and 4:30 p.m. (PST).*

Contact us by mail:  
Baby Trend, Inc.  
1607 S. Campus Ave., Ontario, CA 91761

Contact us by phone:  
1-800-328-7363 (8:00am ~ 4:30pm PST)  
or online <http://www.babytrend.com>

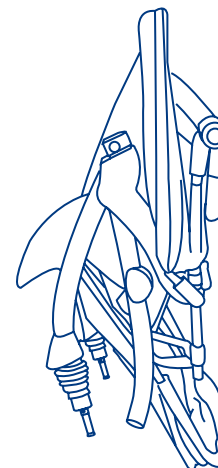

Stroller

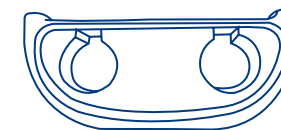

Child Tray



Parent Tray

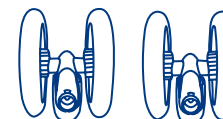

Front Wheel



Rear Axle

## OPTIONAL PARTS



Infant Car Seat

Infant car seat comes with a stay in car base. Base types vary. Please refer to the manual located under the car seat for base type and instructions.

**IMPORTANT!** To ensure safe operation of your stroller, please follow these instructions carefully. Please keep these instructions for future reference.

**IMPORTANT!** Before assembly and each use, inspect this product for damaged hardware, loose joints, missing parts or sharp edges. NEVER use if any parts are missing or broken.

**IMPORTANT!** Adult assembly is required.

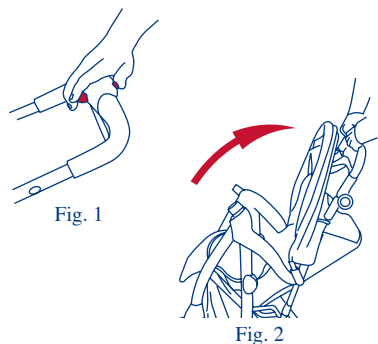

Remove stroller from box. The front wheels, rear wheels, child tray, and parent tray **MUST** be installed prior to use.

### FRONT WHEELS

To attach the front wheels, unfold stroller as described in the section following:

- Unfold stroller frame by sliding the **RED** thumb trigger to the left and squeezing the **RED** pull trigger (Fig. 1) while pulling backward on the stroller handle. (Fig. 2)

To attach the front wheels, lean the stroller back so that it rests on the handle with the front and rear legs pointing upward. Position the front wheels over the front leg tubes so that the hole in the housing lines up and will slide onto the legs. (Fig. 3) Firmly push down until the wheels lock securely into place. Tug on each wheel to ensure they are both securely attached.

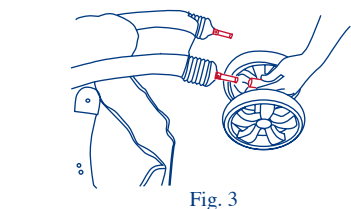

### REAR WHEELS

Attach the rear axle assembly and wheels as follows:

- Position axle assembly over the rear leg tubes, brake pedals facing the back. At the same time, push down applying equal pressure to both sides until they lock into place. (Fig. 4)

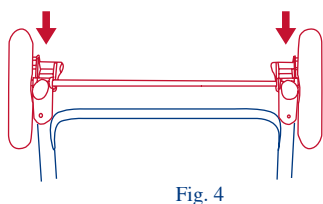

Note: **NEVER** use stroller if wheels do not lock into place. If you need assistance, please contact our customer service department at 1-800-328-7363, M-F, between 8am and 4:30pm, PST.

### CHILD TRAY

To attach the child tray: push the angled side of the tray onto the post at the end of the right armrest while pressing downward on the snap button, until locking in place. (Fig. 5) Rotate the tray downward until it latches onto the left armrest into place. (Fig. 6)

Note: Check that the snap button comes through and securely in place. (Fig. 7)

To remove the child tray: You can remove the tray completely by pressing the snap button on the right side and pulling forward on the tray until released. (Fig. 8)

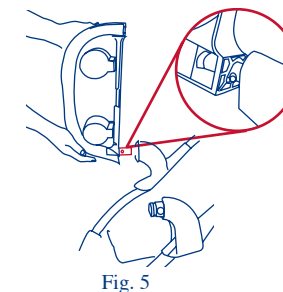

Fig. 5

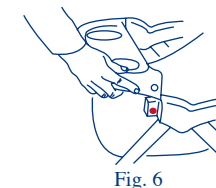

Fig. 6

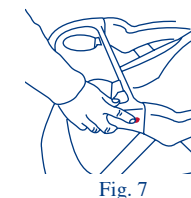

Fig. 7

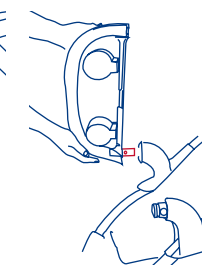

Fig. 8

### PARENT TRAY

To attach parent tray, line up the parent tray slots with corresponding slots on the stroller frame and slide down until locking into place. (Fig. 9) Check to make sure the parent tray is secure before using.

**⚠ WARNING:** Do not place hot liquids or more than 3 pounds in the parent tray. Serious burns or unstable conditions could result.

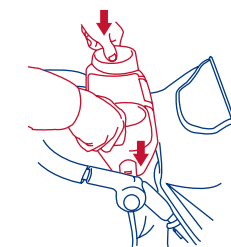

Fig. 9

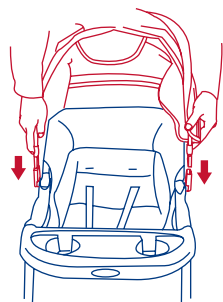

Fig. 10

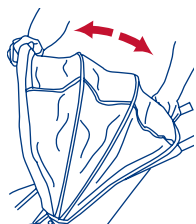
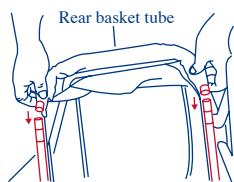

Fig. 11



Basket frame Fig. 12

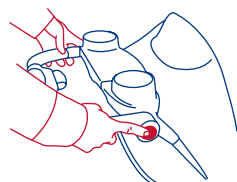

Fig. 13

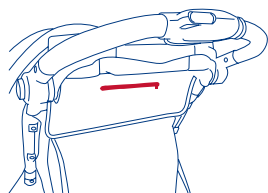

Fig. 14

### CANOPY

To install the canopy, slide the male ends of the canopy into the female slots on the stroller frame. (Fig. 10)

**To open the canopy:** push forward on the front edge of the canopy while holding the rear of canopy in place. (Fig. 11)

**To fold the canopy:** pull backwards on the front edge. (Fig. 11)

### BASKET

Rear basket tube needs to be installed prior to use. Insert the female end of the rear basket tube into the male ends located on the basket frame until it locks into place. (Fig. 12)

### MULTI-POSITION HANDLE

To adjust the handle, press the red buttons to move the handle up or down to a comfort position for the user (Fig. 13)

### INFANT CAR SEAT (if equipped)

Please refer to the infant car seat instruction manual for more details.

### MP3 SPEAKER (if equipped)

The stroller comes with a speaker sewn into a MP3 storage pocket on the back of the stroller. The speaker has a wire with a male jack for use with MP3 player so you and your child can listen to music. (Fig. 14)

**Your stroller is now ready to use.**

Before placing your children in the stroller, please follow the instructions below.

**⚠ WARNING:** Always set brakes when the stroller is not being pushed so that the stroller will not roll away. NEVER leave stroller unattended on a hill or incline as the stroller may slide down the hill.

### BRAKES

To engage brakes, apply light downward pressure to the brake lever located on each rear wheel. The stroller may require slight forward or rearward movement in order to line up the teeth on the brake with each wheel brake cluster. (Fig. 15) Check that the stroller will not move and that both brakes are properly applied. To release, gently lift up on the brake lever.

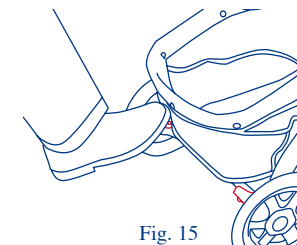

Fig. 15

**⚠ WARNING:** Avoid serious injury from falling or sliding out. Always use the safety harness.

**⚠ STRANGULATION HAZARD:** Child can strangle in loose straps. Never leave child in seat when straps are loose or undone.

### TO SECURE THE CHILD

The shoulder straps of the 5-point harness have 3 attachment positions. Select the position that places the shoulder strap level with, or below the top of the child's shoulder. To adjust harness slot unhook the shoulder strap from the crotch buckle. (Fig. 16) Feed the shoulder strap through the harness spread slots. You can access these slots from the rear of the seat, underneath the fabric. Feed shoulder strap through appropriate slot and reattach shoulder strap to crotch buckle.

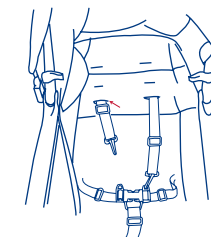
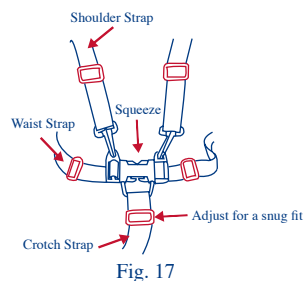
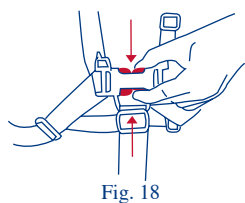

Fig. 16



- Carefully place the child in the stroller seat and bring the safety harness around the child's waist and over the shoulders. Place the crotch strap between the child's legs. Insert the male end of each shoulder/waist belt into the buckle on the crotch strap. Tighten the harness to be snug around the child's waist and over the child's shoulders. Please see figure 17.



- To release, apply pressure to both sides of each male clip until the clip is released. See figure 18. This process requires a moderate amount of effort so as to prevent an accidental release by your child.

**⚠ WARNING:** The upright position should be used only for a child that is at least 6 months old.

### SEAT BACK POSITION

The seat has a multiple position recline that is controlled by a cord and spring loaded adjuster behind the seat. To recline the seat, pull back on the loop of the adjuster. (Fig. 19) To place the seat back in a more upright position, grab the adjuster with one hand and pull the cord to the desired position with the other hand. (Fig. 20) The cord will lock automatically.

**⚠ WARNING:** Never use seat in a reclined carriage position unless enclosure is raised to cover the front opening. Child may slip into leg openings and strangle.

### FULL RECLINE/CARRIAGE POSITION (if equipped)

To recline the seat, pull back on the loop of the adjuster. (Fig. 20) Fold up foot rest and secure with velcro straps through slots on sides. (Fig. 21)

**⚠ WARNING:** Failure to follow these car seat attachment instructions could result in serious injury or death.

### INFANT CAR SEAT ATTACHMENT

To attach the Baby Trend Infant Car Seat, recline the seat all the way back. (Fig. 22)

- Position the Infant Car Seat, facing toward the rear of the stroller, so that the seat shell goes into the front tray and latches into place. (Fig. 23) Check that the Infant Car Seat is firmly locked onto the front tray before using.
- Check that the front child tray is firmly attached to the stroller armrests. Make sure that the car seat locks into the front child tray. Then turn tabs on stroller frame to lock the front of the car seat into the stroller. (Fig. 24)
- To remove the Infant Car Seat, squeeze the release handle located at the foot-end of the seat and carefully lift upward on the seat. (Fig. 25)

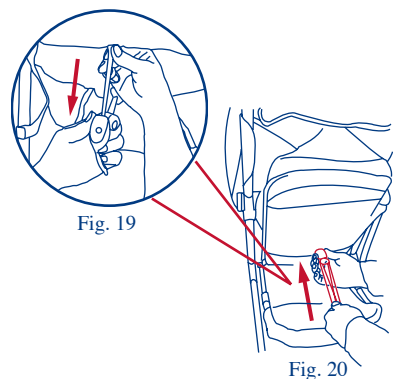
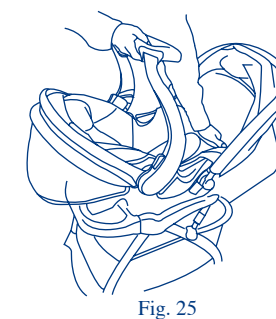
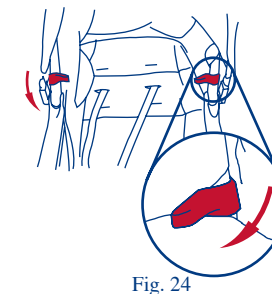
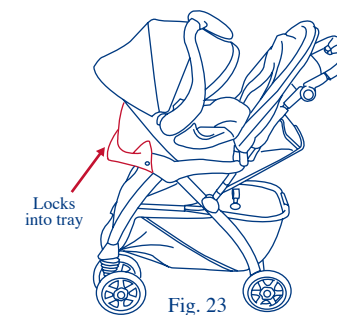
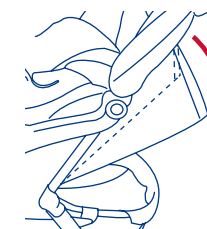
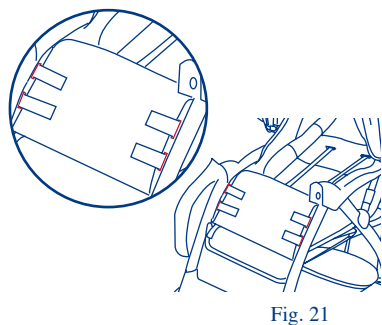

Fig. 20



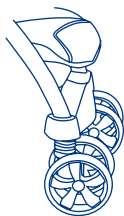

Fig. 26

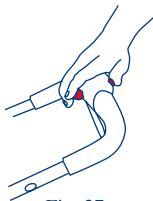

Fig. 27

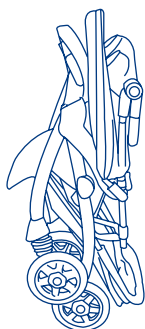

Fig. 28



Fig. 29

**CAUTION:** Read the following section completely before folding your stroller!

**⚠ WARNING:** Care must be taken when folding and unfolding the stroller to prevent finger entrapment.

### TO FOLD STROLLER

- Close the canopy as described in the canopy section.
- Place the seat in the furthest recline position.
- Flip the carseat support tabs to the outside of the stroller frame before folding.
- Pull stroller backward several inches to rotate the front wheels to the front. (Fig. 26)
- To fold the stroller slide the red fold lock with your thumb while squeezing the large red fold button in the center of the handle and push forward on the handle. (Fig. 27)

Once the stroller begins to fold, release the red handle and push forward on the handle until the stroller is folded. (Fig. 28) The stroller will automatically lock when folded correctly, and will stand freely in the folded position.

**⚠ WARNING:** Care must be taken when folding and unfolding the stroller to prevent finger entrapment.

### TO UNFOLD STROLLER

To unfold the stroller slide the red fold lock with your thumb while squeezing the large red fold button in the center of the handle (Fig. 27) and push down on the handle. (Fig. 29)

### SEAT PAD

To clean the seat pad, use only mild household soap or detergent and warm water on a sponge or clean cloth.

### OTHER

Check your stroller for loose screws, worn parts, torn material or stitching on a regular basis. Replace or repair parts as needed.



IF YOU EXPERIENCE ANY DIFFICULTY IN USING THIS PRODUCT, PLEASE CONTACT OUR CUSTOMER SERVICE DEPARTMENT AT 1-800-328-7363 BETWEEN THE HOURS OF 8:00 A.M. AND 4:30 P.M. PACIFIC STANDARD TIME FOR ASSISTANCE. PLEASE HAVE YOUR MODEL NUMBER AND MANUFACTURING DATE AVAILABLE WHEN YOU CALL. THIS INFORMATION CAN BE FOUND ON A SMALL STICKER ON THE INSIDE OF THE STROLLER FRAME.