

Please read all instructions **BEFORE** assembly and **USE** of product.  
**KEEP INSTRUCTIONS FOR FUTURE REFERENCE.**

**baby trend**®

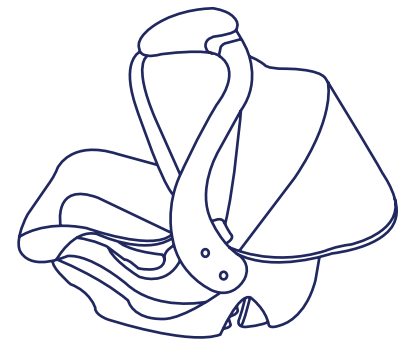

For infant car seat's instructions,  
please refer to the manual located  
under the car seat

**MODEL # 1956CT**

*Serengetti*™ **Travel System**

**Instruction Manual**

Convenience through Innovation and thoughtful design

04.07

## WARNINGS

**⚠️ WARNING:** Please follow all of these instructions to ensure the safety of your child. Keep these instructions for future reference.

**⚠️ WARNING:** Failure to follow these instructions could result in serious injury or death. Avoid serious injury from falling or sliding out. Always use the seat belt and insure that the child is properly positioned according to these instructions.

**⚠️ WARNING:** Never leave child unattended.

- \* Purses, shopping bags, parcels, diaper bags or accessory items may change the balance of the stroller and cause a hazardous, unstable condition.
- \* The maximum weight that can be carried in the storage basket is 5 lbs. The maximum weight that can be carried in the Parent Tray is 3 lbs. Excessive weight may cause a hazardous unstable condition to exist.
- \* Be certain the stroller is completely opened and locked in place before allowing a child near the stroller.
- \* The maximum weight capacity of this stroller is up to 45 pounds additional weight will cause excessive wear and stress on the stroller and may cause a hazardous unstable condition to exist.
- \* **DO NOT** use the stroller on stairways or escalators.
- \* Never allow your stroller to be used as a toy.
- \* To clean use only mild household soap or detergent and warm water on a sponge or clean cloth.
- \* Check your stroller for loose screws, worn parts, torn material or stitching on a regular basis. Replace or repair parts as needed.
- \* Discontinue use of stroller should it malfunction or become damaged. Please contact our customer service department to arrange for repair or obtain replacement parts.

*Please: If you experience any difficulty with the use of our product or have a question regarding these instructions, please contact our Customer Service Department at (800) 328-7363 between the hours of 8:00 am and 4:30 pm Pacific Standard Time or visit us online at [www.babytrend.com](http://www.babytrend.com). Please do not return to the store as once it is returned it cannot be resold and the materials and energy used to make it are wasted.*

To Contact Us:

**Baby Trend, Inc.**  
1567 S. Campus Ave.  
Ontario, CA 91761

**Customer Service Hot Line**  
**(800) 328-7363**  
**8:00 a.m. to 4:30 p.m. Pacific Standard Time**

# PARTS

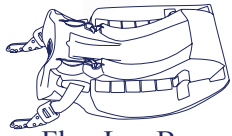

Flex-Loc Base

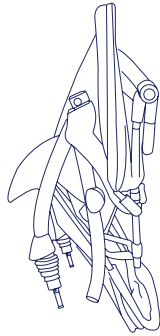

Stroller

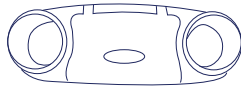

Parent Tray

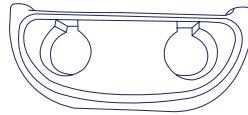

Child Tray



Rear Axle Assembly

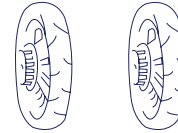

Rear Wheel (2)

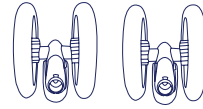

Front Wheel (2)



Locking Washer (2)

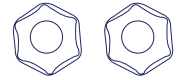

Hub Cap (2)



Solid Cap (2)

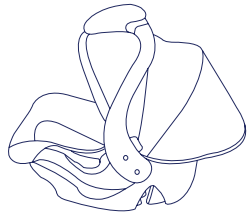

Car Seat

## TO ASSEMBLE STROLLER

**TO ENSURE SAFE OPERATION OF YOUR STROLLER, PLEASE FOLLOW THESE INSTRUCTIONS CAREFULLY. RETAIN THESE INSTRUCTIONS FOR FUTURE REFERENCE.**

- Carefully remove stroller from the carton. Note: Front wheels, rear wheels, child tray and parent tray **MUST** be installed before using.
- Unfold stroller frame by sliding the **RED** thumb trigger to the left and squeezing the **RED** pull trigger while pulling backward on the stroller handle. (Fig. 1-2)
- To attach the front wheels, lean the stroller back so that it rests on the handle with the front and rear legs pointing upward. Position the front wheels over the front leg tubes so that the hole in the housing lines up and will slide onto the legs. (Fig. 3) Firmly push down until the wheels lock securely into place. Tug on each wheel to ensure they are both securely attached.
- Attach the rear axle assembly and wheels as follows:
  - Position axle assembly over the rear leg tubes, brake pedals facing the back. At the same time, push down applying equal pressure to both sides until they lock into place. (Fig. 4)
  - Slide a wheel onto each side of the axle. (Fig. 5)
  - Secure both wheels using with a locking washer. Push locking washer firmly in place. (Fig. 6a)
  - Cap axle end using the solid metal caps. (Fig. 6b)
  - Cover and finish using hubcaps. (Fig. 6c)

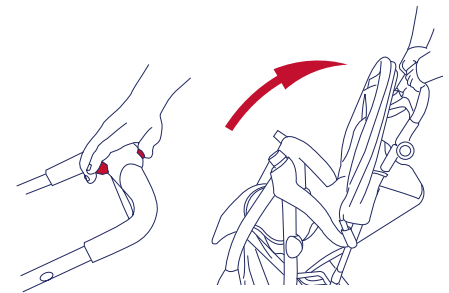

Fig. 1

Fig. 2

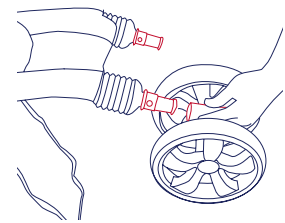

Fig. 3

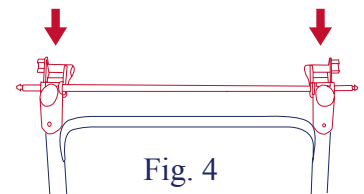

Fig. 4

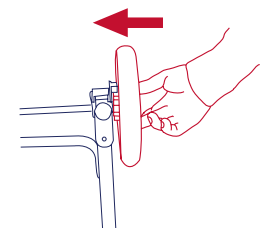
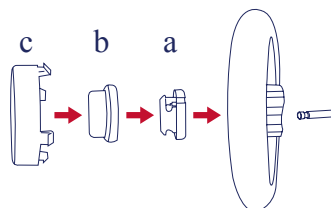

Fig. 5

Pull on both wheels to ensure they are secure and can spin freely.  
 Note: **DO NOT** use stroller if wheels do not lock into place. If you need assistance, please contact our customer service department at (800) 328-7363, M-F, between 8am and 4:30pm, PST.

5. To attach the child tray; push the angled side of the tray onto the post at the end of the right armrest while pressing downward on the snap button, until locking in place. (Fig. 7) Rotate the tray downward until it latches onto the left armrest into place. (Fig.8) Note: Check that the snap button comes through and securely in place. (Fig. 9) You can remove the tray completely by pressing the snap button on the right side and pulling forward on the tray until released. (Fig.10)
6. To install the canopy, slide the male ends of the canopy into the female slots on the stroller frame. (Fig.11) Open canopy, by pushing forward on the front frame of the canopy. Close canopy by pulling backwards. (Fig.12)
7. To attach parent tray, line up the parent tray slots with corresponding slots on the stroller frame and slide down until locking into place. (Fig. 13) Check to make sure the parent tray is secure before using. (Fig. 14)

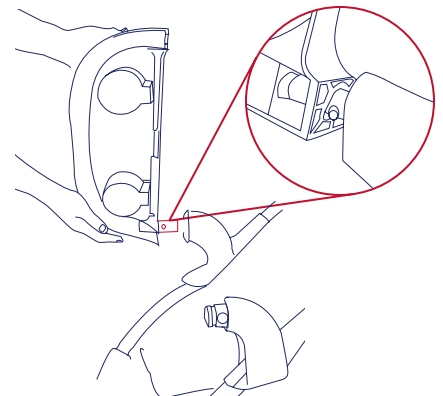

Fig. 7

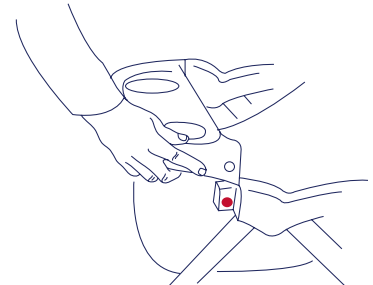

Fig. 8

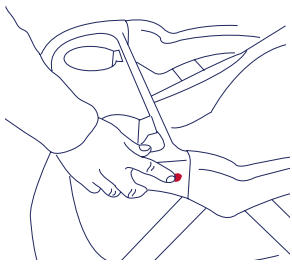

Fig. 9

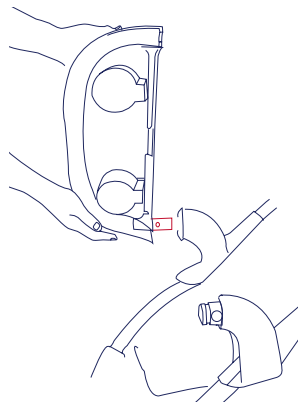

Fig. 10

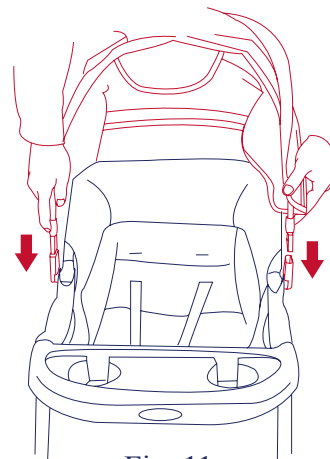

Fig. 11

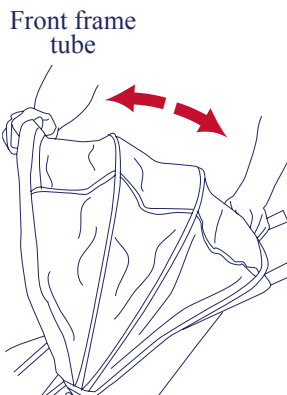

Fig. 12

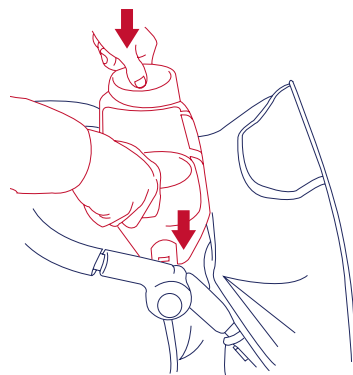

Fig. 13

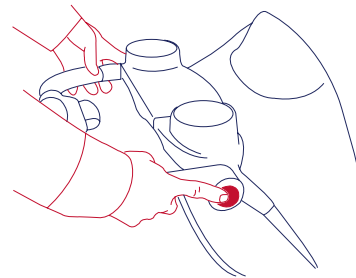

Fig. 14

## TO SECURE THE CHILD

- The shoulder straps of the 5-point harness have 3 attachment positions. Select the position that places the shoulder straps level with, or below the top of the child's shoulders. To access the harness spread slots in seat pad. (Fig. 15)
- Carefully place the child in the stroller seat and bring the safety harness around the child's waist and over the shoulders. Place the crotch strap between the child's legs. Insert the male end of each shoulder/waist belt into the buckle on the crotch strap. Tighten the harness to be snug around the child's waist and over the child's shoulders. (Fig. 16)
- To release, apply pressure to both sides of each male clip until the clip is released. This process requires a moderate amount of effort so as to prevent an accidental release by your child. (Fig. 17)

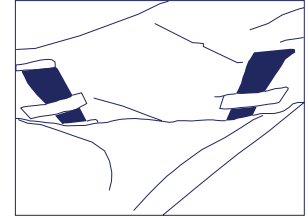

Fig. 15

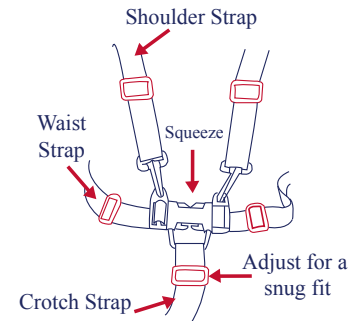

Fig. 16

**⚠ WARNING: Always use the safety harness to avoid serious injury from falling or sliding out.**

**⚠ STRANGULATION HAZARD: Child can strangle in loose straps. Never leave child in seat when straps are loose or undone.**

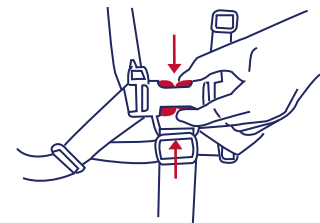

Fig. 17

## ATTACHMENT OF THE BABY TREND INFANT CAR SEAT

- \* To attach the Baby Trend Infant Car Seat, recline the seat all the way back. (Fig. 18)
- \* Position the Infant Car Seat, facing toward the rear of the stroller, so that the seat shell goes into the front tray and latches into place. (Fig. 19) **Check that the Infant Car Seat is firmly locked onto the front tray before using.**
- \* **Check that the front child tray is firmly attached to the stroller armrests.** Make sure that the car seat locks into the front child tray. Then turn tabs on stroller frame to lock the front of the car seat into the stroller. (Fig. 20)
- \* To remove the Infant Car Seat, squeeze the release handle located at the foot-end of the seat and carefully lift upward on the seat. (Fig. 21)

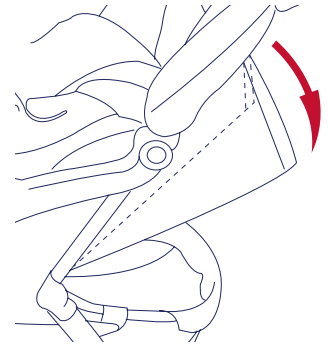

Fig. 18

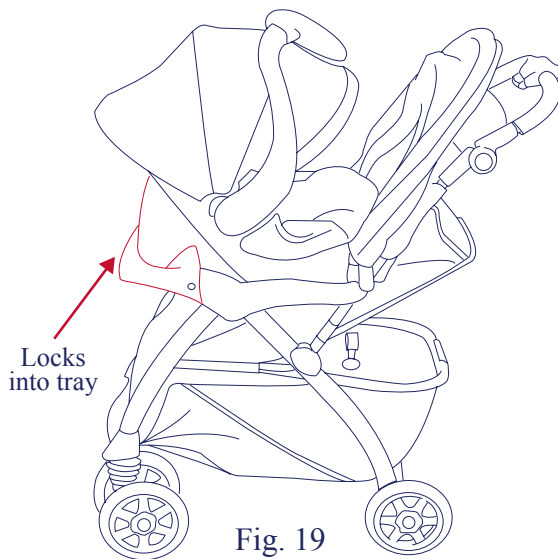

Fig. 19

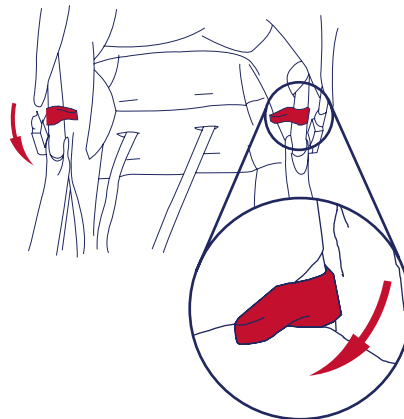

Fig. 20

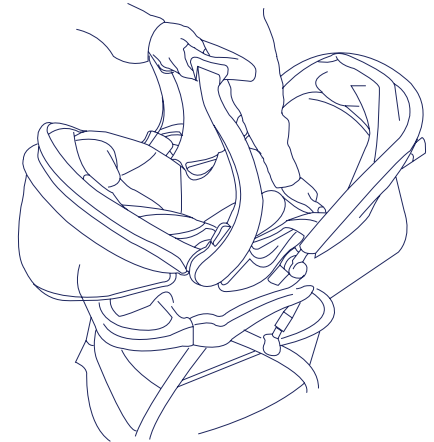

Fig. 21

**⚠️ WARNING: Failure to follow these car seat attachment instructions could result in serious injury or death.**

## SPEAKER IN CANOPY FOR MP3 DEVICE

- \* Use the input jack inside the pocket to plug in your MP3 device. (Fig. 22)

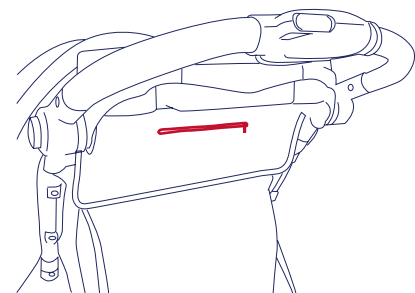

Fig. 22

## SEAT BACK POSITIONING

**⚠️ WARNING:** The upright position should be used only for a child that is at least 6 months old.

\* The seat has a multiple position recline that is controlled by a cord and spring loaded adjuster behind the seat. To recline the seat, pull back on the loop of the adjuster. (Fig. 23) To place the seat back in a more upright position, grab the adjuster with one hand and pull the cord to the desired position with the other hand. (Fig. 24) The cord will lock automatically.

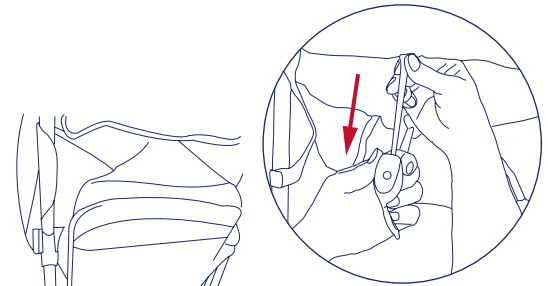

Fig. 23



Fig. 24

## FULL RECLINE/CARRIAGE POSITION

**⚠️ WARNING:** Never use seat in a reclined carriage position unless enclosure is raised to cover the front opening. Child may slip into leg openings and strangle.

\* To recline the seat, pull back on the loop of the adjuster. (Fig. 23) Fold up foot rest and secure with velcro straps through slots on sides. (Fig. 25)

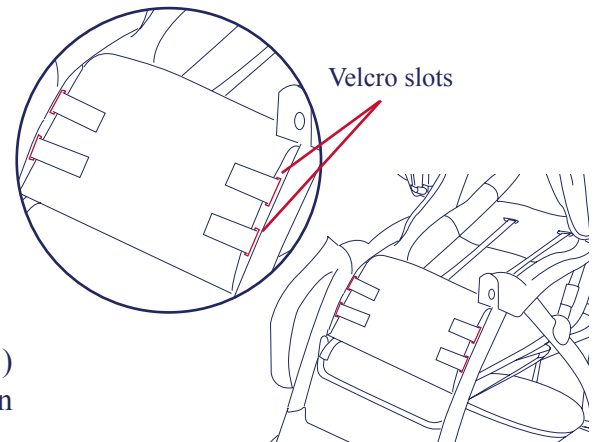

Fig. 25

## BRAKES

**⚠️ WARNING:** Always set brakes when the stroller is not being pushed so that the stroller will not roll away. Never leave stroller unattended on a hill or incline as the stroller may roll away.

\* To engage brakes, apply light downward pressure to the brake lever located on each rear wheel. The stroller may require slight forward or rearward movement in order to line up the teeth on the brake with each wheel brake cluster. (Fig. 26) Check that the stroller will not move and that the brakes are properly applied. To release, gently lift up on the brake lever.

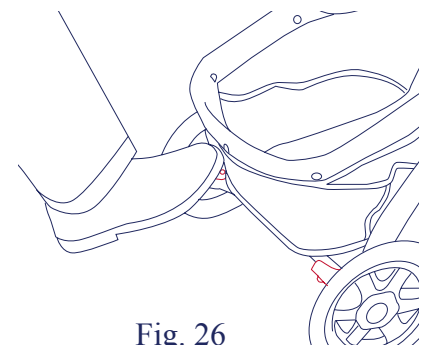

Fig. 26

## CANOPY

- \* To open the canopy, push forward on the front frame of the canopy. To close canopy, pull the front edge toward the rear of the stroller until folded. Always close the canopy prior to folding the stroller frame. (Fig. 27)

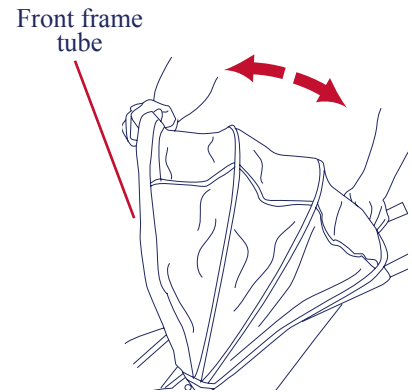

Fig. 27

## TO FOLD STROLLER

**CAUTION: Read the following section completely before folding your stroller!**

1. Close the canopy as described in the canopy section.
2. Place the seat in the furthest recline position.
3. Flip the carseat support tabs to the outside of the stroller frame before folding.
4. Pull stroller backward several inches to rotate the front wheels to the front. (Fig. 28)
5. To fold the stroller slide the red fold lock with your thumb while squeezing the large red fold button in the center of the handle and push forward on the handle. (Fig. 29)

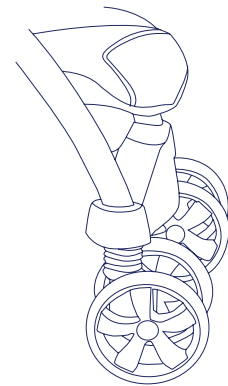

Fig. 28

Once the stroller begins to fold, release the red handle and push forward on the handle until the stroller is folded. (Fig. 30) To stroller will automatically lock when folded correctly, and will stand freely in the folded position.

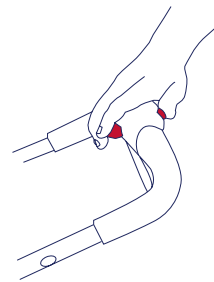

Fig. 29



Fig. 30

**⚠ WARNING: Failure to follow these folding instructions could result in serious injury or death.**

## TO UNFOLD STROLLER

- \* To unfold the stroller slide the **red** fold lock with your thumb while squeezing the large **red** fold button in the center of the handle and push down on the handle.

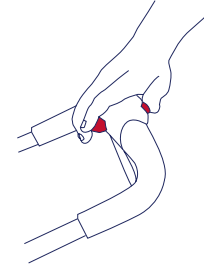

Fig. 31

**⚠ WARNING:** Failure to follow these folding instructions could result in serious injury or death.

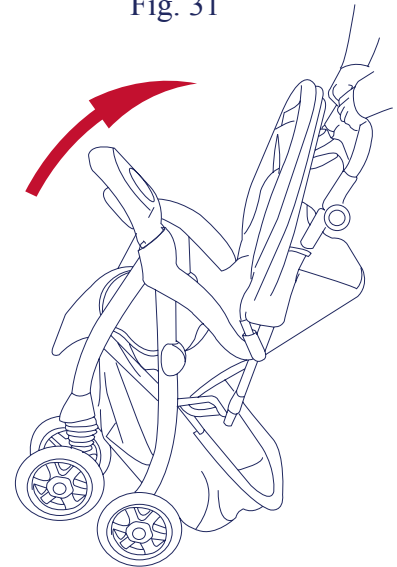

Fig. 32

## CLEANING SEAT PAD

- \* To clean the seat pad, use warm water, soap and a sponge, and let air dry.



**IF YOU EXPERIENCE ANY DIFFICULTY IN USING THIS PRODUCT,  
PLEASE CONTACT OUR CUSTOMER SERVICE DEPARTMENT AT (800) 328-7363  
BETWEEN THE HOURS OF 8:00AM AND 4:30PM PACIFIC STANDARD TIME OR VISIT US ONLINE  
AT [WWW.BABYTREND.COM](http://WWW.BABYTREND.COM) FOR ASSISTANCE.**

