

Read all instructions **BEFORE** assembly and **USE** of product.
KEEP INSTRUCTIONS FOR FUTURE USE.

baby trend[®]

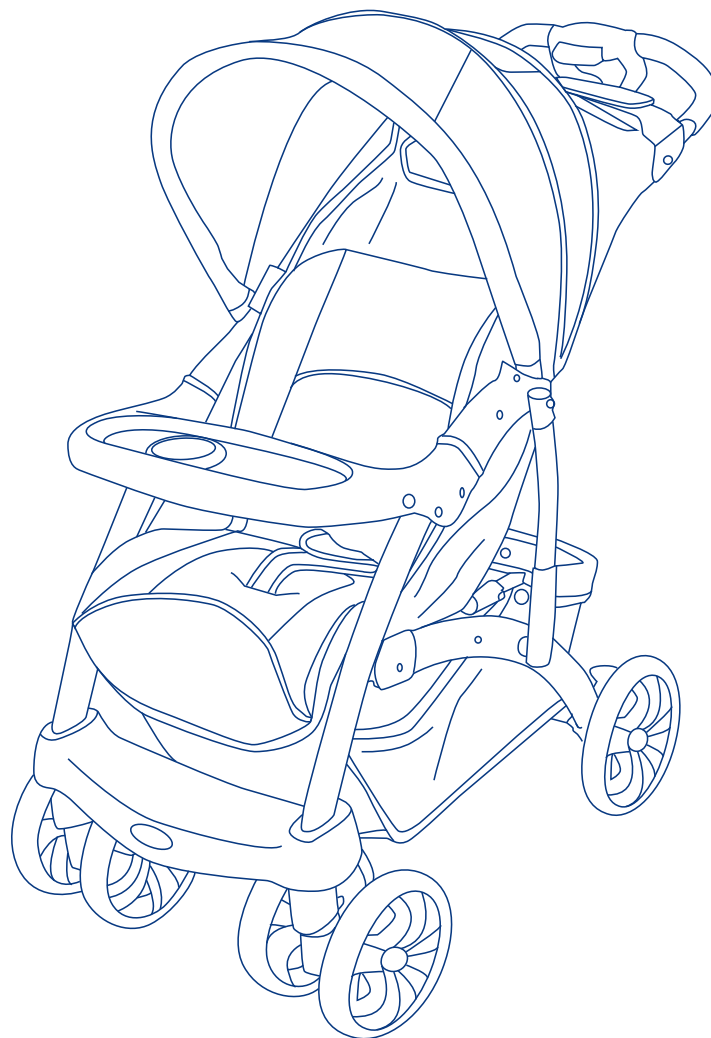

MODEL # 1981CT

Patents pending, US Patent# 6,834,915 6,811,216 6,913,313 6,916,066

Shuttle Travel System

Instruction Manual

WARNINGS

 **WARNING:** Please follow all of these instructions to ensure the safety of your child. Keep these instructions for future reference.

 **WARNING:** Failure to follow these instructions could result in serious injury or death. Avoid serious injury from falling or sliding out. Always use the seat belt and insure that the child is properly positioned according to these instructions.

 **WARNING:** Never leave child unattended.

- * Purses, shopping bags, parcels, diaper bags or accessory items may change the balance of the stroller and cause hazardous unstable conditions.
- * The maximum weight that can be carried in the basket is 5 lbs. The maximum weight that can be carried in the Parent Tray is 3 lbs. Excessive weight may cause a hazardous unstable condition to exist.
- * Be certain the stroller is fully erect and latched in the open position before allowing the child near the stroller.
- * Use of the stroller with a child weighing more than 45 pounds will cause excessive wear and stress on the stroller and may cause a hazardous unstable condition to exist.
- * DO NOT use the stroller on stairways or escalators.
- * Never allow your stroller to be used as a toy
- * To clean use only mild household soap or detergent and warm water on a sponge or clean cloth.
- * Check your stroller for loose screws, worn parts, torn material or stitching on a regular basis. Replace or repair parts as needed
- * Discontinue use of stroller should it malfunction or become damaged. Please contact our customer service Parts Hotline to arrange for repair or obtain replacement parts.

Please: If you experience any difficulty with the use of our product or have a question regarding these instructions, please contact our Customer Service Department at (800) 328-7363 between the hours of 8:00 am and 4:30 pm Pacific Coast Time. Please do not return to the store as once it is returned it cannot be resold and the materials and energy used to make it are wasted.

To Contact Us:

Baby Trend, Inc.
1567 S. Campus Ave.
Ontario, CA 91761

Customer Service Hot Line
(800) 328-7363
8:00 a.m. to 4:30 p.m. Pacific Standard Time

PARTS

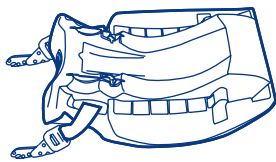

Base



Car Seat

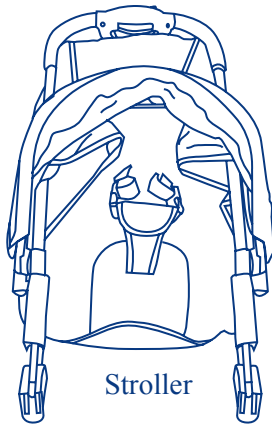

Stroller



Child Tray



Parent Tray

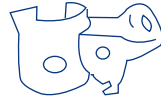

Rear Wheel Housing

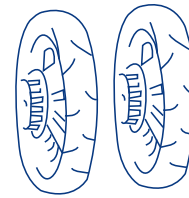

Rear Wheels

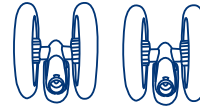

Front Wheels

Rear Axle



Locking Cap



Hub Cap



Solid Cap

TO ENSURE SAFE OPERATION OF YOUR STROLLER, PLEASE FOLLOW THESE INSTRUCTIONS CAREFULLY. RETAIN THESE INSTRUCTIONS FOR FUTURE REFERENCE.

TO ASSEMBLE STROLLER

* Remove stroller from box. The front wheels, rear wheels, child tray, parent tray, and canopy need to be installed prior to use.

* To attach the front wheels, unfold stroller as described in the section following. See figure 1.

* Lean the stroller backwards so that it rests on the handle and rear frame tubes and the front wheel tubes are pointing upward. Position the front wheel assembly at the front tube such that the hole in the swivel assembly will slide onto the front tube. Please see figure 2. Push each front wheel assembly onto the front tube being careful that wheel assembly locks onto the front leg. Pull on the wheel assembly to ensure that it is securely attached to the stroller. Please see figure 2.

* Lean the stroller forward to rest on the front wheels. Assemble the rear wheels as follows:

1. Slide the rear wheel housings onto each rear stroller leg until locked into place. The push button on the forward edge of the leg should snap into the hole in the housing. Please see figure 3.
2. Slide the rear axle through the housings as shown in figure 4.
3. Slide each wheel onto the rear axle and secure in place with the Locking Cap. Snap the solid cap over the Locking Cap. Snap the Hub Cap onto the wheel. Please see figure 5. Please see figure 6 for order assembly.

Pull on each wheel to ensure that each is firmly attached to the axle.

* Ensure that the wheels are firmly locked into place. Do Not use the stroller if the wheels are not locked into place, but rather contact our customer service department immediately at (800) 328-7363, between the hours of 8:00am and 4:30pm PCT, for assistance.

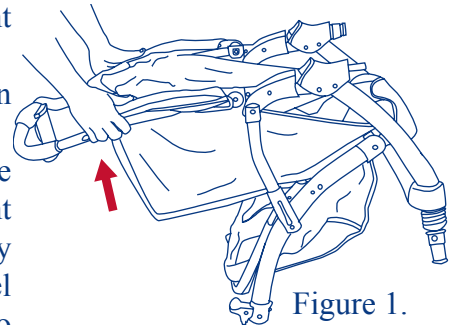

Figure 1.

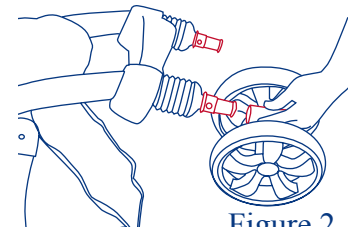

Figure 2.

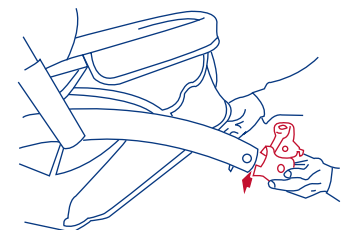

Figure 3.

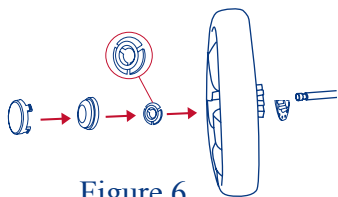

Figure 6.

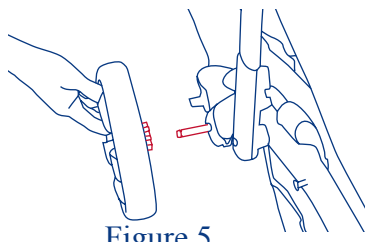
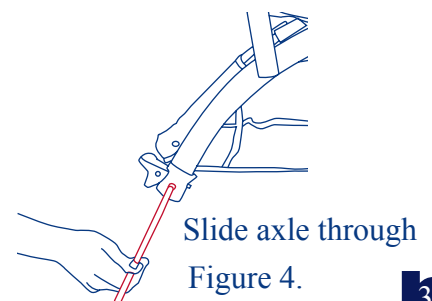

Figure 5.



Slide axle through
Figure 4.

* To attach the front child tray, push the angled tray onto the post at the end of right armrest, while pressing downward on the snap button, until locked into place. Please see figure 7. Rotate the tray downward until latched onto the left armrest. Please check that the snap button comes through and securely latches the tray in place. Please see figure 8.

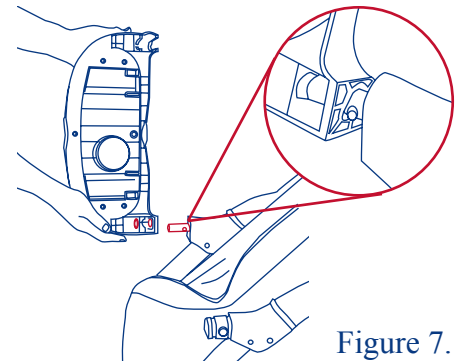

Figure 7.

* To remove front child tray, press inward on the left side tray release button and rotate upward on the tray. Please see figure 9. Please note that you may remove the tray completely by depressing the snap button on the right side as shown in figure 10 while pulling forward on the tray. Please see figure 7.

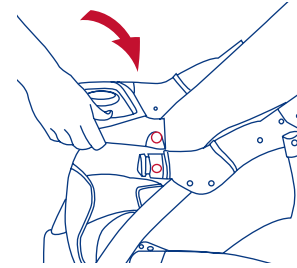

Figure 8.

* To attach the parent tray, align the fittings on the ends of the parent tray with the fittings on the outsides of the handle, make sure to push the canopy forward. See figure 11a. Push downward on the tray until locked into place. Please see figure 11. To remove the parent tray, pull outward on the bottom edges of the tray and lift upward. Please see figure 12.

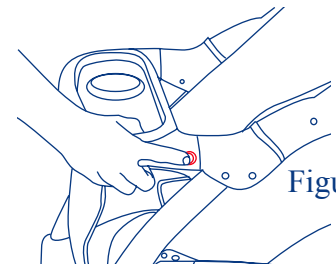

Figure 9.

* The Drop-Top storage basket swings downward to allow easy access to the basket contents. Lift upward on the rear tube of the basket to lock in the up position. Please see figure 13. To lower the basket, pull rearward on the center of the basket tube and press downward. Please see figure 14.

* To remove the canopy, pull outward on the fittings on the canopy as shown in figure 15. Push forward on the front frame of the canopy to open. Please see figure 16.

Your stroller is now ready to use.

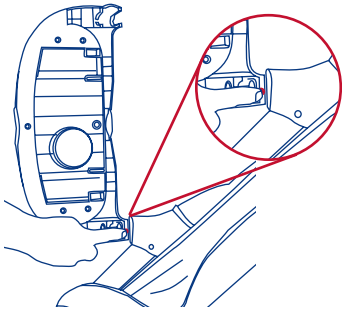

Figure 10.

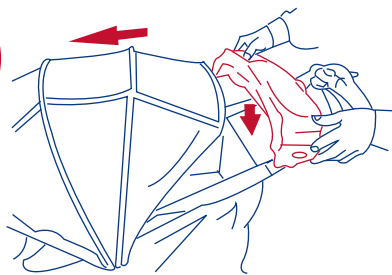

Figure 11a.

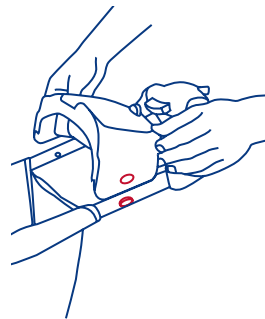

Figure 11.

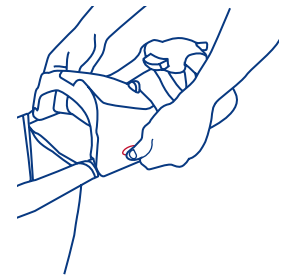

Figure 12.

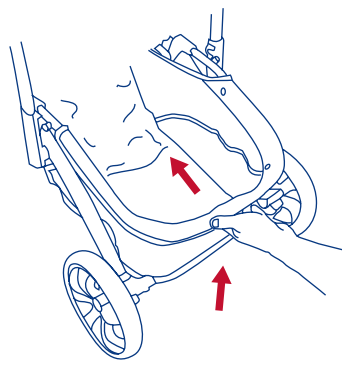

Figure 13.

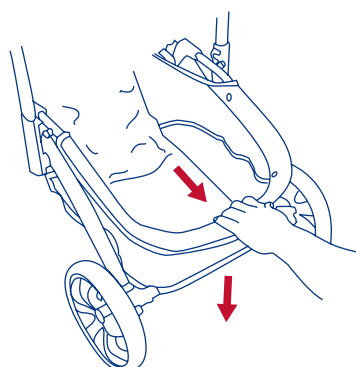

Figure 14.

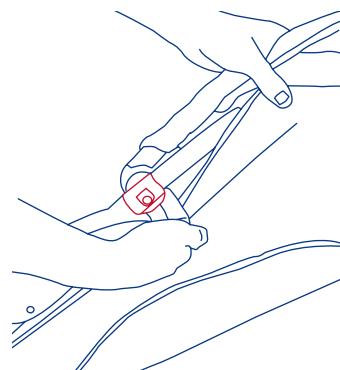

Figure 15.

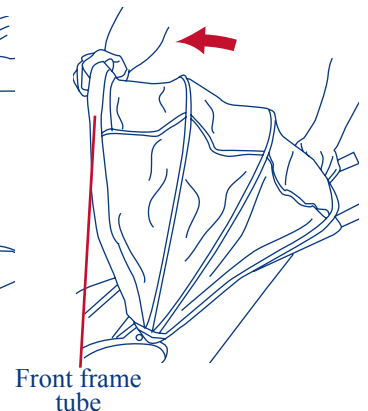

Figure 16.

TO SECURE THE CHILD

- The shoulder straps of the 5-point harness have 2 attachment positions. Select the position that places the shoulder strap level with, or below the top of the child's shoulder. To access the harness pull apart seat pad. Please see figure 17.
- Carefully place the child in the stroller seat and bring the safety harness around the child's waist and over the shoulders. Place the crotch strap between the child's legs. Insert the male end of each shoulder/waist belt into the buckle on the crotch strap. Tighten the harness to be snug around the child's waist and over the child's shoulders. Please see figure 18.

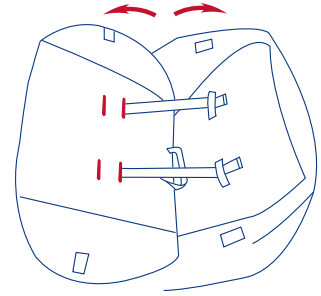

Figure 17.

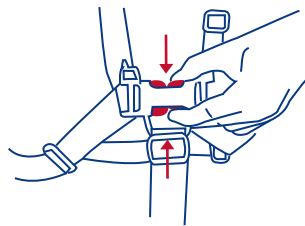

Figure 18a.

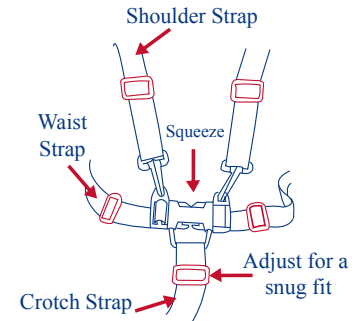

Figure 18.

- To release, apply pressure to both sides of each male clip until the clip is released. See figure 18a. This process requires a moderate amount of effort so as to prevent an accidental release by your child.

⚠ WARNING: Avoid serious injury from falling or sliding out. Always use the safety harness.

⚠ STRANGULATION HAZARD: Child can strangle in loose straps. Never leave child in seat when straps are loose or undone.

ATTACHMENT OF THE BABY TREND INFANT CAR SEAT

- * To attach the Baby Trend Infant Car Seat, place seat back in the partially reclined position as described in the seat back positioning section following. Please see figure 25 and 26.
- * **Check that the front child tray is firmly attached to the stroller armrests.** Pull rearward on the rear edge of the front child tray cover while lifting upward on the tray cover. Please see figure 19 and 20. Remove the tray cover and store in the pocket in the rear of the seat. Please see figure 21.
- * Position the Infant Car Seat, facing toward the rear of the stroller, so that the seat shell goes into the front tray and latches into place. The sides of the car seat will rest on fold joints. Please see figure 22. **Check that the Infant Car Seat is firmly locked onto the front tray before using.**
- * To remove the Infant Car Seat, squeeze the release handle located at the foot-end of the seat and carefully lift upward on the seat. Please see figure 23.

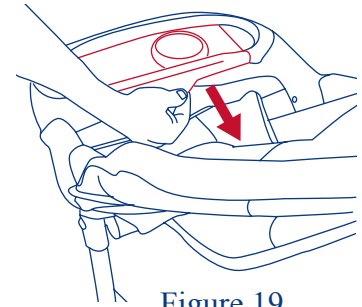

Figure 19.

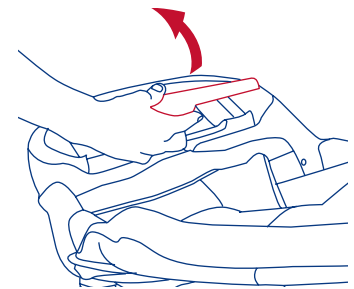

Figure 20.

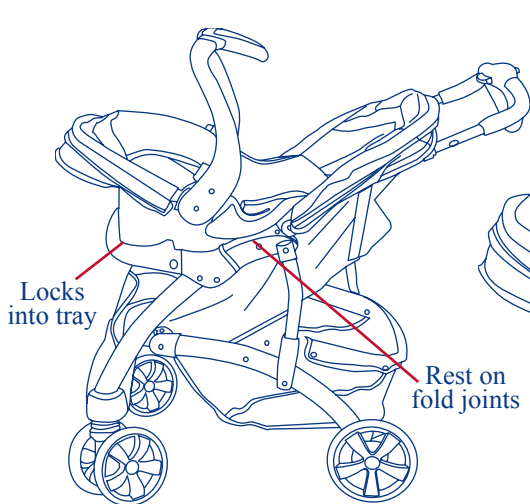

Figure 22.

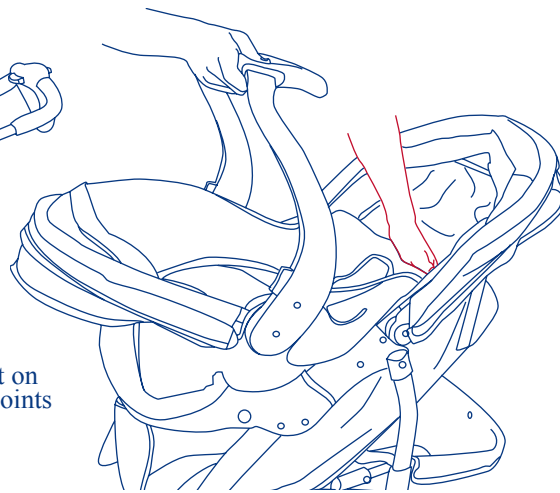

Figure 23.

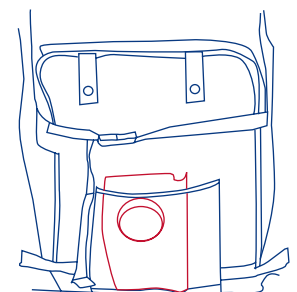

Figure 21.

FRONT CHILD / CAR SEAT TRAY COVER

- * The cover of the child/car seat tray may be fastened in the closed position after your child outgrows the infant car seat. This will prevent an older child from opening the child tray. To secure the tray cover, remove the tray from the stroller as shown in the to remove front child tray section. Install the tray cover. Place the tray with the lid side down on a soft flat surface. Remove the screw stored under the tray as shown in figure 24. Insert the screw into the hole in the bottom of the tray and into the matching hole in the cover. Tighten until snug. Do not over tighten. If you wish to use the car seat tray function at a later date (for a second child) remove the screw and store in the tray bottom as before. Please see figure 24.

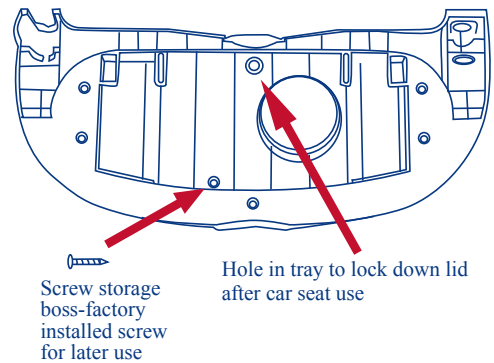

Figure 24.

SEAT BACK POSITIONING

⚠ WARNING: The upright position should be used only for a child that is at least 6 months old.

- * The seat has a multiple position recline that is controlled by a strap and buckle assembly behind the seat. To recline the seat, loosen the strap through the buckle and adjust to the required recline position. Please see figure 25. To place the seat back in a more upright position, press upward on the seat back with one hand while pulling the straps through the buckle with the other. See figure 26. The strap will lock automatically. Strap must go across slot on either side of central seat body when adjusting seat back height. See figure 26a.

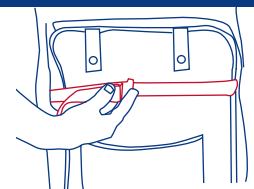

Figure 25.

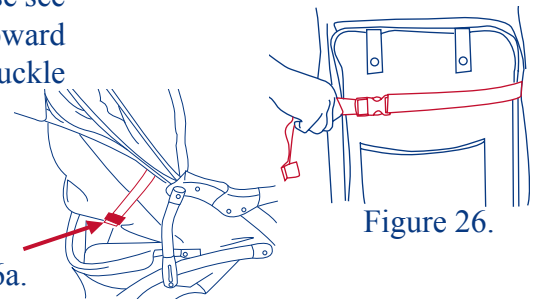

Figure 26.

Figure 26a.

BRAKES

⚠ WARNING: Always set brakes when the stroller is not being pushed so that the stroller will not roll away. Never leave stroller unattended on a hill or incline as the stroller may slide down the hill.

- * To engage brakes, apply light downward pressure to the brake lever located on each rear wheel. The stroller may require slight forward or rearward movement in order to line up the teeth on the brake with each wheel brake cluster. See figure 27. Check that the stroller will not move and that the brakes are properly applied. To release, gently lift up on the brake lever.

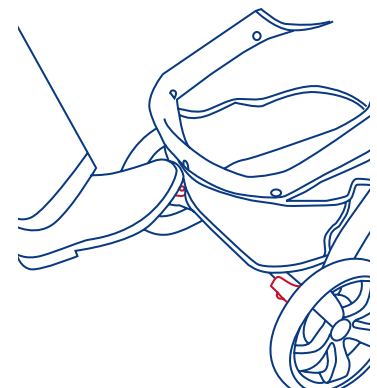

Figure 27.

CANOPY

- * To open the canopy, push forward on the front frame of the canopy. To close canopy, pull the front edge toward the rear of the stroller until folded. Always fold the canopy prior to folding the stroller frame. Please see figure 28. The canopy may be moved forward to block the sun or wind. Push forward on the front frame tube or rearward on the rear frame tube to adjust. Please see figure 29.

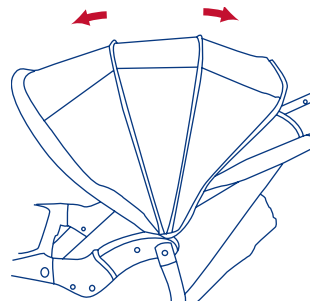

Figure 29.

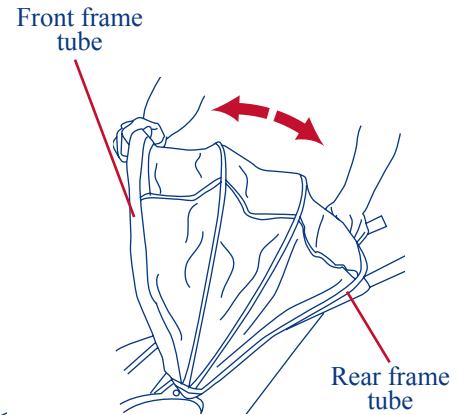

Figure 28.

TO REMOVE FRONT CHILD TRAY

- * To remove front child tray, press inward on the tray release button on the left armrest and pull up on the tray. Please see figure 9. Also, the tray may be completely removed by depressing the snap button on the right side as shown in Figure 10 while pulling forward on the tray

BASKET

- * The Drop-Top storage basket swings downward to allow easy access to the basket contents. Lift upward on the rear tube of the basket to lock in the up position. Please see figure 30. To lower the basket, pull rearward on the center of the basket tube and press downward. Please see figure 31.

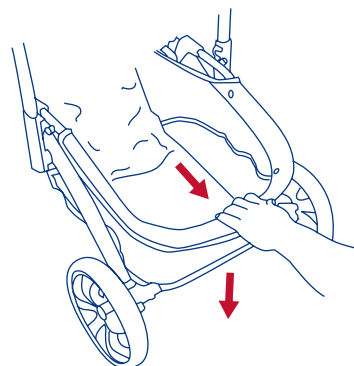

Figure 31.

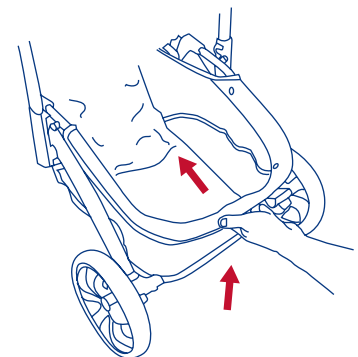

Figure 30.

TO FOLD STROLLER

- * Close the canopy as described in the Canopy section above. **Place seat back in fully reclined position by unbuckling recline strap.** Pull stroller backward several inches to rotate the front wheels to the front. Please see figure 32. To fold the stroller slide the red fold lock with your thumb while squeezing the large red fold button in the center of the handle and push downward on the handle. Once the stroller begins to fold, release the red handle and pull rearward on the child tray until the stroller is folded. Please see figure 33. Secure the stroller in the folded position by fastening the fold locking latch, located on the right side of the stroller at the intersection of the handle and the armrest, over the extended rivet on the lower frame tube. The latch should easily reach the rivet. If not, check for interference-DO NOT force the stroller. Please see figure 34.

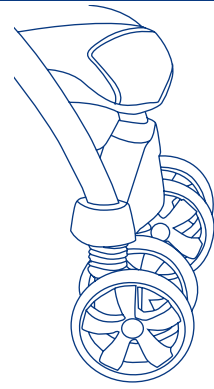

Figure 32.

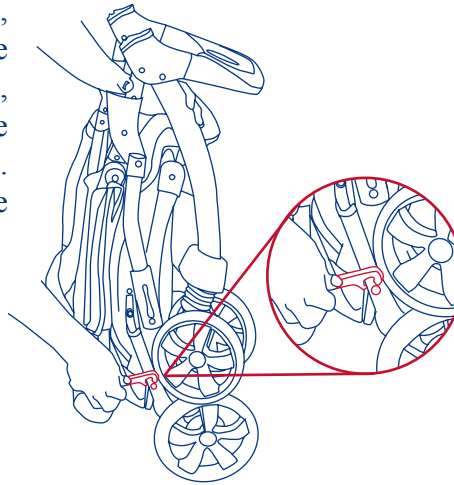

Figure 34.

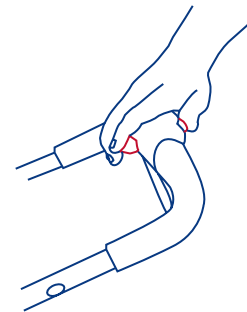

Figure 33.

TO UNFOLD STROLLER

- * Release the folding latch, which is located on the right side. See figure 35.
- * Lift up on the stroller handle with both hands until the stroller frame is erect and locked in the open position. See figure 36. The stroller has spring-loaded latches on both sides of the frame. Test that both latches are fully engaged prior to placing your child in the stroller.

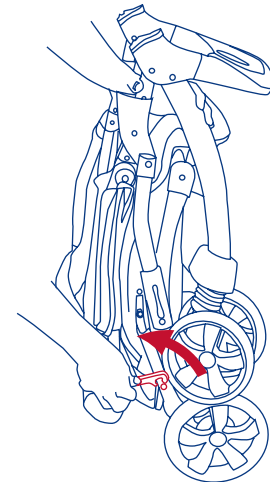

Figure 35.

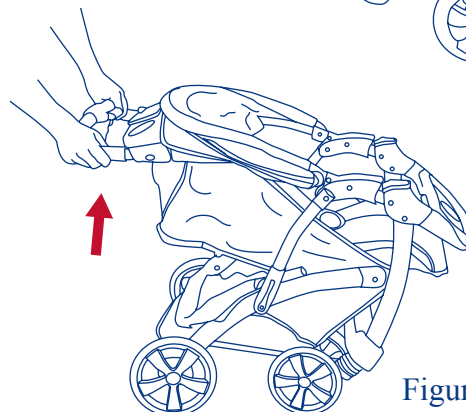

Figure 36.

CLEANING SEAT PAD

* The seat pad may be removed for washing. To remove the seat pad, unstrap the two straps on the rear of the seat as shown in figure 37. Unfasten the seat belt and pull the waist belts and crotch strap through the cutouts in the pad as shown in figure 38. Pull downward on the front edge of the seat pad to remove from the stroller as shown in figure 39. Please see the care label on the rear of the seat for washing instructions. To re-install the pad, follow these instructions in reverse order.

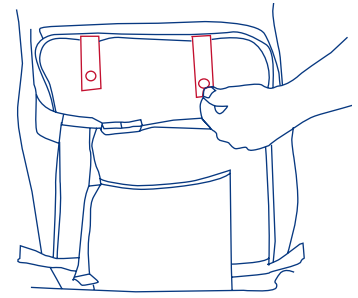

Figure 37.

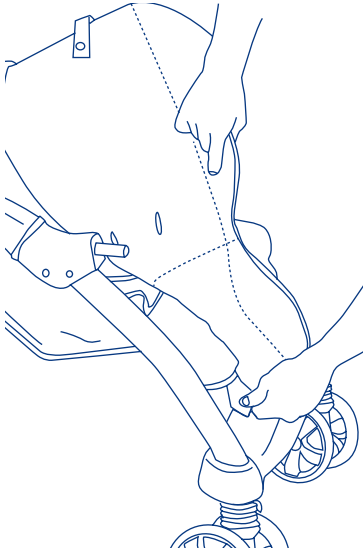

Figure 39.

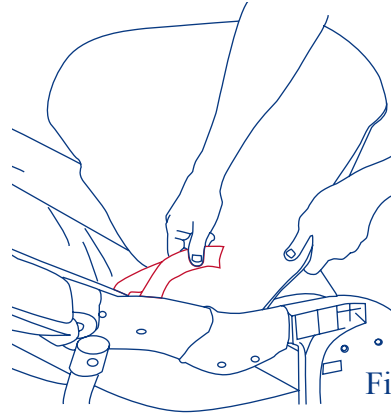

Figure 38.



**IF YOU EXPERIENCE ANY DIFFICULTY IN USING THIS PRODUCT,
PLEASE CONTACT OUR CUSTOMER SERVICE DEPARTMENT AT (800) 328-7363
BETWEEN THE HOURS OF 8:00AM AND 4:30PM PACIFIC COAST TIME FOR ASSISTANCE.**