

Read all instructions **BEFORE** assembly and **USE** of product.
KEEP INSTRUCTIONS FOR FUTURE USE.

baby trend[®]

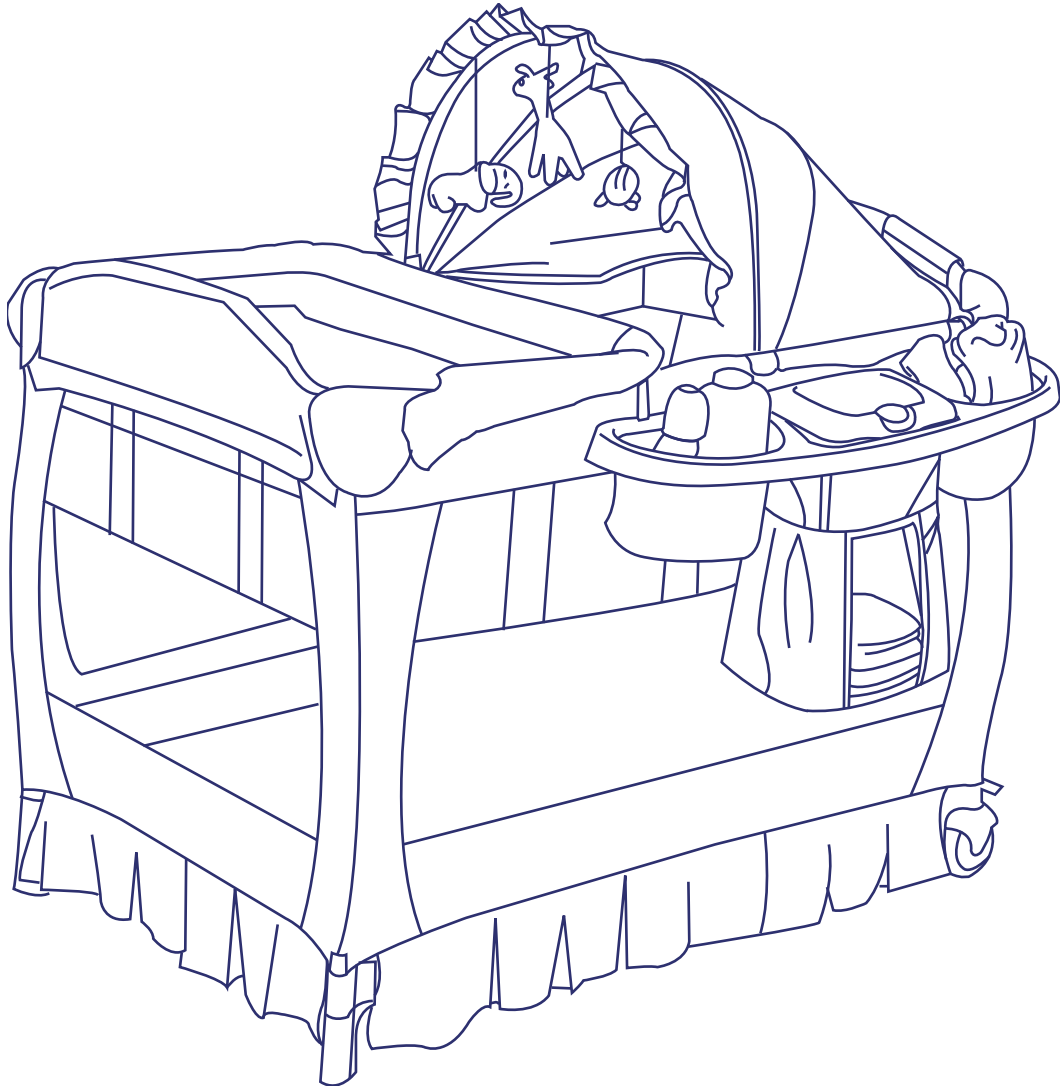

Model #8206BCC

DELUXE TREND NURSERY CENTER

Instruction Manual

Read all instructions **BEFORE** assembly and **USE** of Playard. **KEEP INSTRUCTIONS FOR FUTURE USE.**

⚠️ WARNING: FAILURE TO FOLLOW THESE WARNINGS AND THE ASSEMBLY INSTRUCTIONS COULD RESULT IN SERIOUS INJURY OR DEATH FROM ENTRAPMENT, STRANGULATION, SUFFOCATION, ETC.

⚠️ WARNING: INFANTS CAN SUFFOCATE: IN GAPS BETWEEN A MATTRESS TOO SMALL OR TOO THICK AND PRODUCT SIDES, ON SOFT BEDDING. NEVER ADD A MATTRESS, PILLOW, COMFORTER, OR PADDING. USE ONLY THE MATTRESS PROVIDED BY MANUFACTURER.

- To reduce the risk of SIDS, pediatricians recommend healthy infants be placed on their back to sleep, unless otherwise advised by your physician.
- Never leave changer on top of playard when child is in the playard. Always flip changer to the outside when not in use.
- IF REFINISHING, USE A NONTOXIC FINISH SPECIFIED FOR CHILDREN'S PRODUCTS.
- **DO NOT** LEAVE CHILD IN PRODUCT WITH SIDE LOWERED.
- BE SURE SIDE IS IN RAISED AND LOCKED POSITION WHENEVER CHILD IS IN PRODUCT.
- The Playard, including side rails, must be fully erect prior to use. **Make sure locks are secure.**
- Discontinue use of the Playard when child is able to climb out or reaches the height of 35 inches (890 mm) or the weight of 30 lbs.. (14 kg)
- When child is able to pull to a standing position, remove bumper pads, large toys, and other objects that could serve as steps for climbing out.
- Always provide the supervision necessary for the continued safety of your child. When used for playing, never leave child unattended.
- Strings can cause strangulation! **DO NOT** place items with a string around the child's neck, such as hood strings or pacifier cords. **DO NOT** suspend strings over a Playard/crib or attach strings to toys.
- **DO NOT** place the Playard near a window where cords from blinds or drapes can strangle a child. **DO NOT** add padding or other objects inside the Playard that will permit your child to climb out. Keep Playard away from stoves, heaters, campfires and other hazards.
- Never use plastic shopping bags or other plastic film as mattress covers not sold and intended for that purpose. They can cause suffocation.
- Before each usage or assembly, inspect product for damaged hardware, loose joints, missing parts, or sharp edges. **DO NOT** use Playard if any parts are missing or broken. Please contact Baby Trend Customer Service for replacement parts, repair or instructional literature if needed. **DO NOT** substitute parts.
- **DO NOT** use a water mattress with this product.
- This product is not intended for commercial use.

MAINTENANCE AND CLEANING INSTRUCTIONS: *Use only household soap or detergent and warm water. *NO BLEACH.

Please: If you experience any difficulty with the use of our product or have a question regarding these instructions, please contact our Customer Service Department at (800) 328-7363 between the hours of 8:00 a.m. and 4:30 p.m. Pacific Standard Time. Please do not return the product to the store as once it is returned it cannot be re-sold and the materials and energy used to make it are wasted.

To Contact Us:

Baby Trend, Inc.
1567 S. Campus Ave.
Ontario, CA 91761

Customer Service Hot Line
(800) 328-7363
8:00 a.m. to 4:30 p.m. Pacific Standard Time

FOR THE SAFETY OF YOUR CHILD, PLEASE READ THE INSTRUCTIONS COMPLETELY BEFORE ASSEMBLING THE PLAYARD, BASSINET AND CHANGING AREA

TO ASSEMBLE PLAYARD

CONTENTS (Fig. 1-1):

- 1 Playard
- 1 Mattress
- 1 Organizer
- 2 Leg extensions (1 Left, 1 Right)
- 2 Leg extensions (1 Left, 1 Right) with Wheels, and hardware
- 1 Travel or Storage bag

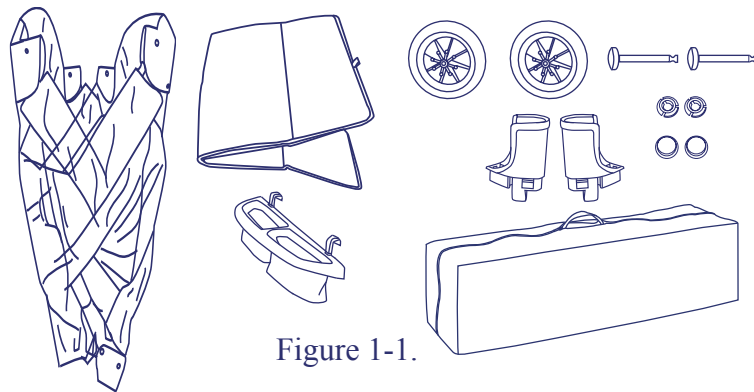

Figure 1-1.

BEFORE YOU BEGIN: The Baby Trend Playard is designed so that, when properly setup, the fabric of the playard places pressure on the 4 top rails making them nearly impossible to unlock. This safety feature is activated when you push down on the playard floor to lock the bottom rails. When setting up the playard, if you allow the bottom rails to lock before locking the top rails, the fabric pressure will not allow you to lock the top rails. Please see (Fig. 7.) for the proper position of the bottom of the playard when locking the top rails. Always keep fingers away from corners when setting playard up.

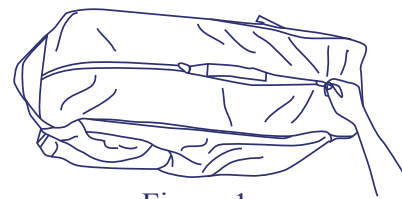

Figure 1.

- 1. Unzip bag and remove Playard frame (Fig. 1). Undo the 3 Velcro straps and set mattress aside (Fig. 2).
- 2. Turn the playard upside down. (Fig. 3). Push each leg extension into the bottom of the leg until both sides of extension snap into place. (Fig. 4). Check that the extension is firmly connected. Attach the wheels to the playard with the axle and nut as shown in figure (Fig. 5). The brake cluster on the wheel must face to the inside. The axle is inserted from the outside to the inside. (Fig. 6). Check that the wheels are firmly connected.
- 3. Stand Playard on legs keeping feet of playard close together as shown in (Fig. 7). Pull up on top rails until all rails “click” and “lock”.

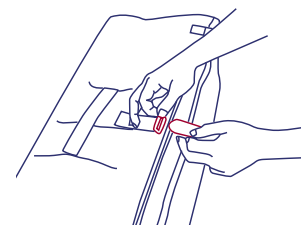

Figure 2.

* **READ IMPORTANT: In order to continue, the handle in the center of the floor of the Playard MUST remain raised in order for the rail to lock (approx. 45.7 cm or 18 inches). The feet of the playard should almost touch each other. All 4 bottom rails must be pointed upward in order to LOCK top rails.**

- 4. Push down on center of Playard floor until it is flat and locks into position (Fig. 8). The center lock mechanism will lock automatically.

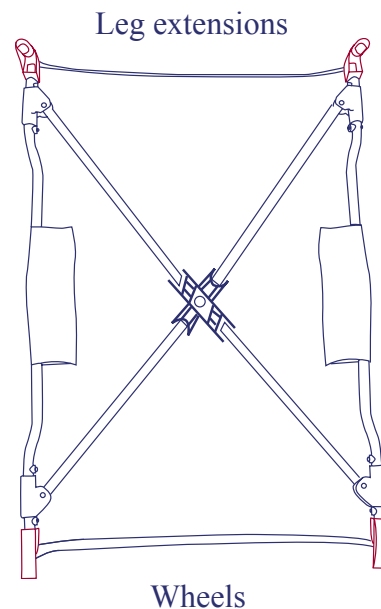

Figure 3

NOTE: Test rails to make sure they are locked. Push down on each rail making sure they are rigid and in a set position.

⚠️ WARNING: All top rails **MUST** be straight and locked in position or child may become entrapped and suffocate.

See figure 9 and 10.

- Place mattress in Playard with padded side up (Fig. 11).

NOTE: DO NOT insert mattress if using bassinet feature. Go to bassinet instructions.

- Feed the 3 hook and loop straps (found underneath the mattress), through the slots on the bottom of the sides of the Playard. Fasten the hook and loop straps to the underside of Playard to prevent the mattress from moving (Fig. 12) (Fig. 13).

⚠️ WARNING: To prevent child from becoming entrapped under the mattress pad and suffocating, hook and loop straps **MUST** be secured to underside of Playard.

- The organizer can attach to any side of the playard. Insert the plastic hooks into the organizer as shown in (Fig 14). For best results, attach the organizer on the long side of the playard.
- Attach the organizer, by pushing the plastic clips down over the top rail. (Fig. 14 A). The maximum weight capacity of the organizer is 3 pounds.
- To operate the brakes on the wheels, press downward on the brake lever as shown in figure 15. To release, lift upward on the lever.

Assembly is now complete and playard is ready to use.

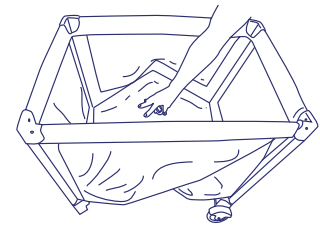
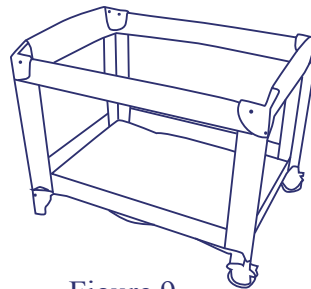
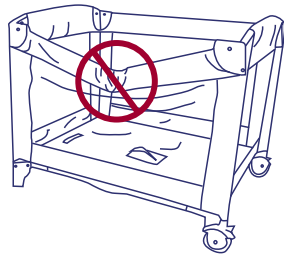
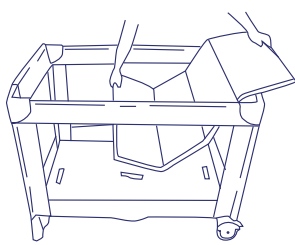
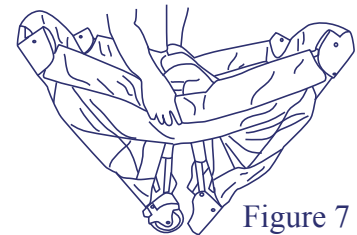
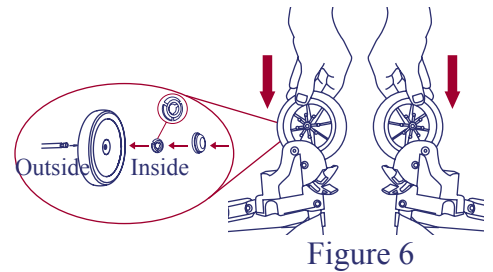
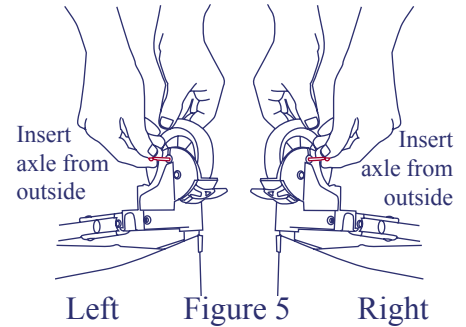
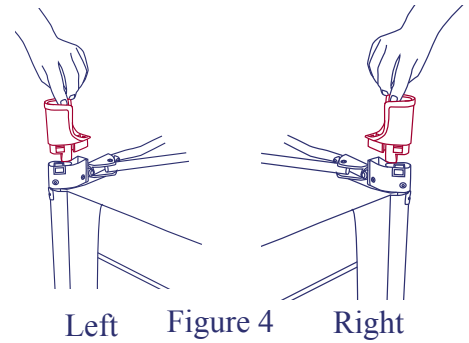

Figure 11

Figure 10

Figure 9

Figure 8

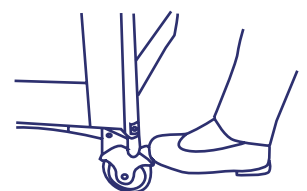
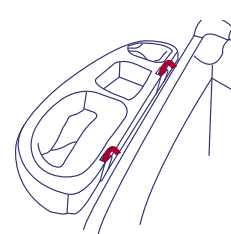
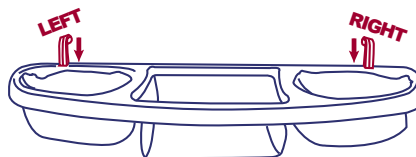
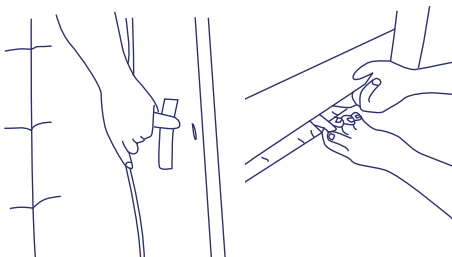

Figure 12

Figure 13

Figure 14

Figure 14A

Figure 15

FOLDING PLAYARD

1. Undo the 3 hook and loop straps holding mattress from underneath Playard floor. (If mattress is not used in the bassinet). Remove mattress and set aside.
2. Grasp the center floor strap and lift upward until handle is as high as the top rails. Gather the four feet of the playard together so that they nearly touch each other. See figure 1 and 2.

NOTE: TOP RAILS OF THE PLAYARD ARE STILL IN THE “LOCKED” POSITION.

3. Locate release button on the center of the bottom of each top rail. Lift slightly while squeezing button until the rail clicks. Push down on rail (while still holding release button in) until side forms a “U”. Repeat for remaining sides (Fig. 3).

NOTE: If top rail(s) do not form the “U” completely do not force. Check the floor of your Playard to make sure all bottom rails are unlocked and pull up on middle handle of floor again. Repeat step 3.

4. Pull up on handle in center of Playard (Fig. 4). Gather legs of Playard together.
5. Wrap mattress around Playard frame with padded side facing in.
6. Secure the 3 hook and loop straps by feeding through loops on end of mattress and folding back onto itself (Fig. 5).
7. Place Playard in carry bag so handle comes through opening between zippers.

⚠ WARNING: NEVER LEAVE INFANT IN PRODUCT WITH SIDES DOWN. Infant may roll into space between pad and loose mesh side causing suffocation.

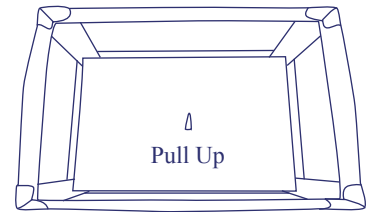

Figure 1

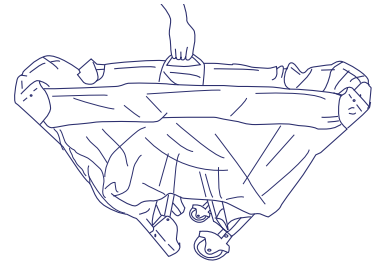

Figure 2

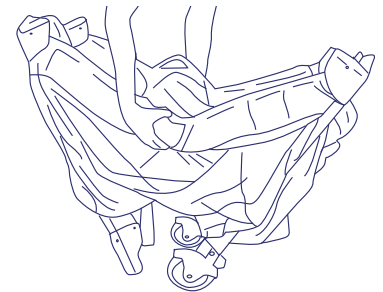

Figure 3



Figure 4

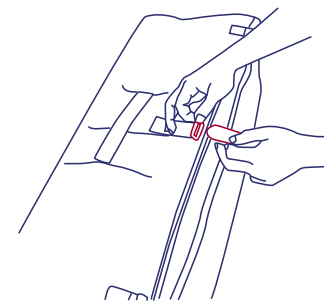

Figure 5



PLAYARD BASSINET/CHANGING AREA 01.06

⚠️ WARNING: FAILURE TO FOLLOW THESE WARNINGS AND THE ASSEMBLY INSTRUCTIONS COULD RESULT IN SERIOUS INJURY OR DEATH FROM ENTRAPMENT, STRANGULATION, SUFFOCATION, ETC.

- To reduce the risk of SIDS, pediatricians recommend healthy infants be placed on their back to sleep, unless otherwise advised by your physician.
- Always provide the supervision necessary for the continued safety of your child. When used for playing, never leave child unattended.
- Adult supervision is always necessary when using your bassinet.
- Your playard, including side rails and bottom pad, must be fully erected prior to use.
- Top rails must be locked.
- Bottom rails must be in flat, locked position.
- **SUFFOCATION HAZARD:** To help prevent suffocation from entrapment, use only the mattress provided by Baby Trend®. Never use additional mattress or padding. Never use plastic shipping bags or other plastic film as mattress covers not sold and intended for that purpose. Avoid **SUFFOCATION HAZARD** caused by a loose sheet. A fitted sheet is recommended. The fitted sheet must fit the mattress tightly.
- **STRANGULATION HAZARD: DO NOT** place items with a string around child's neck, such as hood strings or pacifier cords. **DO NOT** suspend string over bassinet or attach strings to toys.
- **DO NOT** add padding or other objects inside your bassinet which will permit a child to climb out.
- To prevent your child from falling out of the bassinet discontinue using your bassinet when your child is too active, able to climb out, weighs over 15 lbs.. (6.8 kgs.), or is over 4 months old.
- Use changer with infant who's weight is less than 18 lbs (8.2 kg) and is less than 25 inches (63.5 cm) tall.
- Discontinue use of changer if infant can push up on hands and knees or sit unassisted.
- **DO NOT** use a water mattress with this bassinet.
- Use your bassinet with only one child at a time.
- Keep bassinet away from stoves, heaters, campfires and other hazards.
- Never place a child under the bassinet.
- Never leave changer on top of playard with a child in the playard. Always flip changer to the outside when not in use.
- **DO NOT** store the bassinet in the playard.
- The bassinet must be fully assembled and installed, including top rails and bottom pad, before using.
- Before each use or assembly, inspect the playard and bassinet / changing area for damaged hardware, loose joints, missing parts or sharp edges. **DO NOT** use playard or bassinet if any parts are missing or broken. Call our Customer Service department at (800) 328-7363 for replacement parts.
- To protect your child from falls and other injuries: always use safety belt when child is on the changing table, always stay within arm's reach of your child when using the changing table, never leave child unattended.

Baby Trend, Inc.
1567 S. Campus Ave.
Ontario, CA 91761

Customer Service Hot Line:
(800) 328-7363
8:00 A.M. to 4:30 P.M. Pacific Standard Time

TO ASSEMBLE YOUR BASSINET

NOTE: Playard *MUST* be in a locked set-up position before installing and using the bassinet feature.

CONTENTS:

- 1 Nylon Bassinet Insert

ASSEMBLY

NOTE: The printed warning label should be facing toward the inside of the bassinet so that it is readable. The bassinet is oriented with the canopy opposite from the changing area.

1. The top corner pieces of the playard with slots as shown in (Fig. 1) is the changing area end. Locate the 4 pieces of hook and loop fasteners on the bassinet insert (as shown in Fig. 2) which hold the canopy. Orient the bassinet with the hook and loop fasteners at the opposite end from the changing table as shown in (Fig. 3).
2. Place assembled bassinet onto the Playard. Push down each of the bassinet supports onto the playard frame as shown in (Fig. 4).
3. Place the Playard mattress into the bassinet with the padded side facing up as shown in (Fig. 5).
4. Connect the canopy to the Playard frame as shown in (Fig. 6)
PLEASE NOTE THE CANOPY IS INTENDED FOR INDOOR USE ONLY.

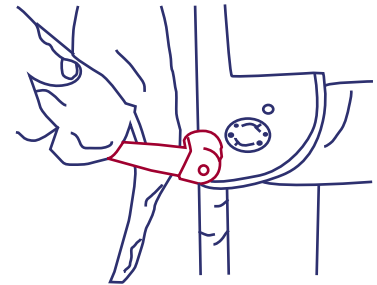

Figure 1

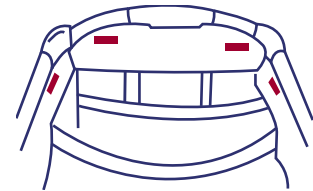

Figure 2

CHANGING TABLE END

CANOPY END

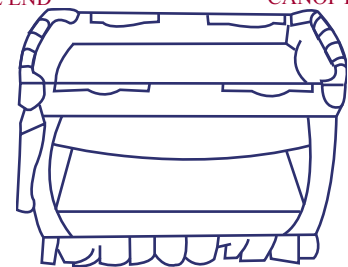

Figure 3.



Figure 6.

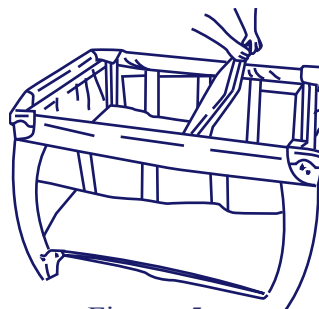

Figure 5.

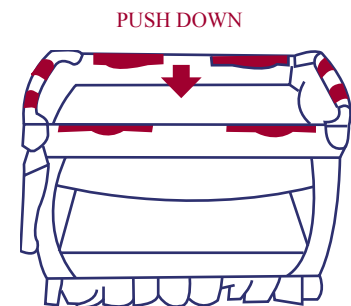

Figure 4.

TO ASSEMBLE CHANGING AREA

CONTENTS (Fig. 1):

- 2 Long curved bars
- 2 Short bars with connector knobs
- 1 Changing area fabric

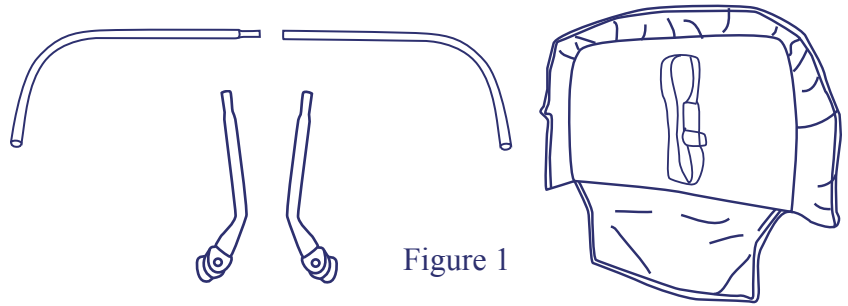

Figure 1

⚠️ WARNING:

Avoid serious injury or death:

- **Always use** restraint belt to prevent falls
- Use changer with infant who's weight is less than 18 lbs (8.2 kg) and is less than 25 inches (63.5 cm) tall.
- Discontinue use of changer if infant can push up on hands and knees or sit unassisted.
- **DO NOT** carry changer with infant in it.
- Always stay within arms reach of your child when using the changing area.

⚠️ **WARNING:** Strangulation Hazard
Child can lift the changing table and get neck trapped between the changing table frame and the play yard frame. Never leave the changing table in place when the child is in the bassinet or the play yard. Always flip changer to the outside when not in use.

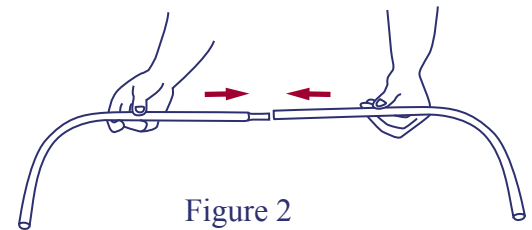

Figure 2



Figure 3

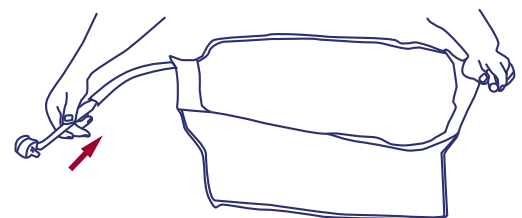
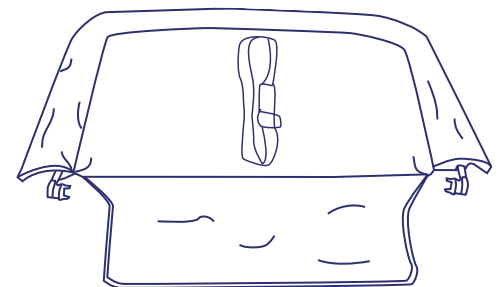

Figure 4.

ASSEMBLY

1. Connect the two Long Curved Bars together as shown in figure 2.
2. Insert the assembled Curved Bars into the Changing Area Fabric such that the holes in the ends of the Curved Bars face downward as shown in Figure 3.
3. Slide the Curved Bars around inside the sleeve of the Changing Area Fabric.
4. Connect the Short Bars with Connector Knobs to the Curved Bars as shown in figure 4. When assembling the Short Bars with Connector Knobs make sure that **the knobs will be facing inward** when assembled and the snap buttons are facing downward.



Completed assembly
Figure 5.

NOTE: Short bar with connector knobs should be facing inward.

5. Place connector knob prongs into holes located on corner pieces of Playard (Fig. 5).
6. Turn connector knobs counter clockwise to lock (Fig. 6).
7. Flip changing area to inside of Playard (Fig. 7).
8. Snap flap from changing area to side of Playard (Fig. 8).
9. Check that changing area is secure before using.

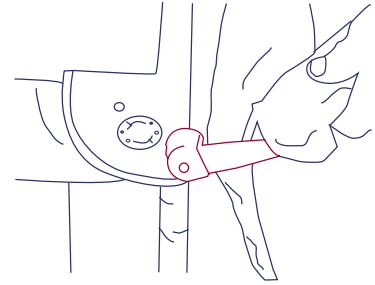

Figure 5.

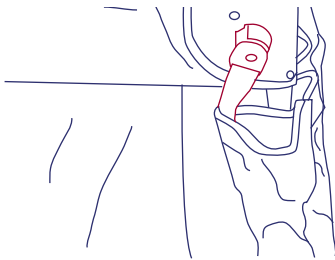

Figure 6.

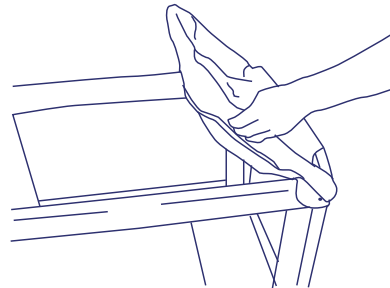

Figure 7.

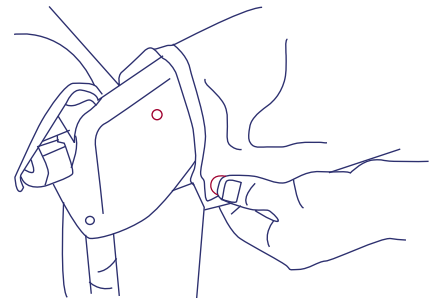

Figure 8.

REMOVAL AND FOLDING CHANGING AREA

REMOVAL

1. Flip changing area to the outside of the Playard. Unsnap fabric flap of changing area from Playard.
2. Twist connector knobs clockwise to unlock (Fig. 1).
3. Remove changing area from Playard (Fig. 2).
4. Disconnect the short bars from the curved bar by pressing on the snap buttons and pulling apart. Remove curved bar from changing area sleeve.

The changing area is now ready for storage.

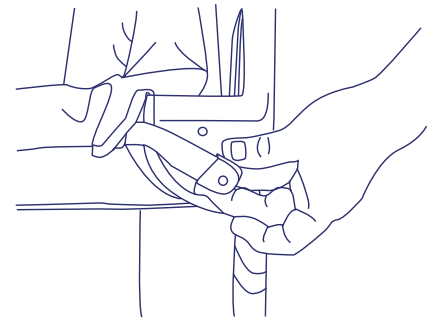

Figure 1.

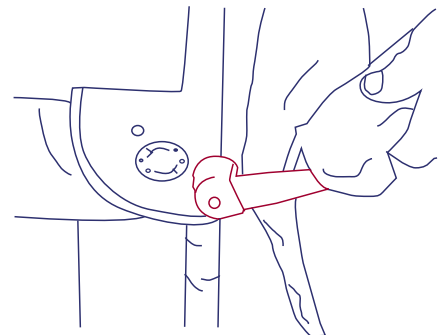

Figure 2.

REMOVAL OF BASSINET

REMOVAL OF BASSINET

1. Remove mattress from bassinet (Fig.1).
2. Remove canopy (Fig. 2).
3. Un snap all clips and lift bassinet out of playard (Fig. 3)

The bassinet is now ready for storage.

NOTE: Store bassinet and changing area with folded Playard in carry bag.

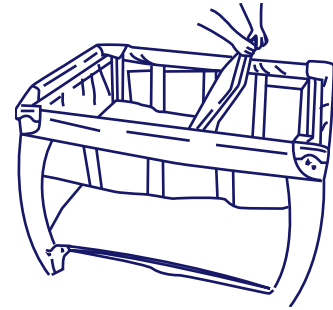

Figure 1

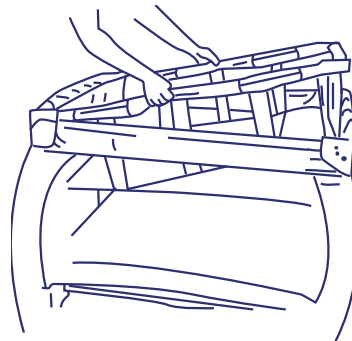

Figure 3

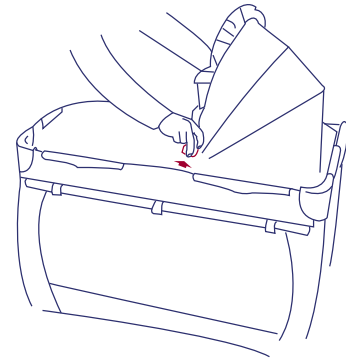

Figure 2

TO REMOVE CANOPY

REMOVAL OF CANOPY

To remove the bassinet canopy, pull upward on the ends of the canopy from the side of the playard. The canopy can be stored in the travel bag.

USING THE MUSIC CENTER

⚠️ WARNING: Keep batteries out of child's reach. Old and new batteries should not be mixed. Alkaline, standard carbon-zinc, and rechargeable nickel-cadium batteries should not be mixed. Remove batteries before storing music center for a long period of time.

MUSIC CENTER

The music center is designed to be attached to the playard as shown in figure 1.



Figure 1

MUSIC OPERATION

The music center requires 4 AA batteries. Please see figure 2 for battery installation. Unscrew the battery door screws and pull outward on the battery door. Install batteries as shown. Re-install battery door and secure with screws.

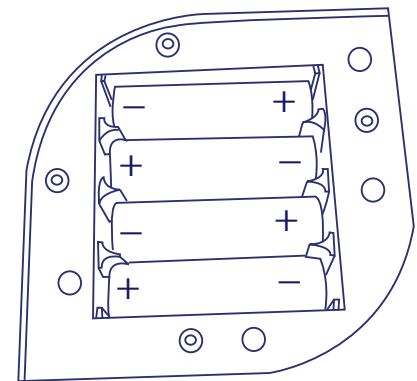

Figure 2



To activate the unit, press the on/off button. Press button a second time to enable voice activation. Press button a third time to switch unit off.



sleep

To listen to SLEEP music, press the SLEEP button. You may use the previous / next button to change the song. The Vol or Vol buttons control the units volume.



play

To listen to PLAY music, press the PLAY button. You may use the previous / next button to change the song. The Vol or Vol buttons control the units volume.



nature

To listen to NATURE sounds, press the NATURE button you may use the previous / next button to change the sound. The Vol or Vol buttons control the units volume.



VIBRATION

To use the vibration button press down once to activate the speed, press again for a Medium speed and once more for the faster speed. Press to reduce the speed.



NIGHT LIGHT

To use the night light, press the button. The light has 3 settings of brightness and is controlled by the button.



VOICE RECORDER

To use the Voice record function press the button and speak into the microphone to record your 10 second voice message. Press to hear the message.



VOICE ACTIVATION

To use the Voice Activation function press the button twice if the unit is power off. If the unit is already power on, press the button once. The voice activation light will be illuminated when in voice activation mode. If your infant cries his/her voice will activate the sleep music to come on and play. When voice activation is enabled, sleep mode is active for 2 hrs.



MP3 FUNCTION

Use the input jack to attach your MP3 player into the unit . Press the button to select the MP3 input. Your MP3 music will then be played thru the unit and will over-ride the unit's music. To listen to the unit's music, depress the button. Volume will be controlled by the MP3 player.

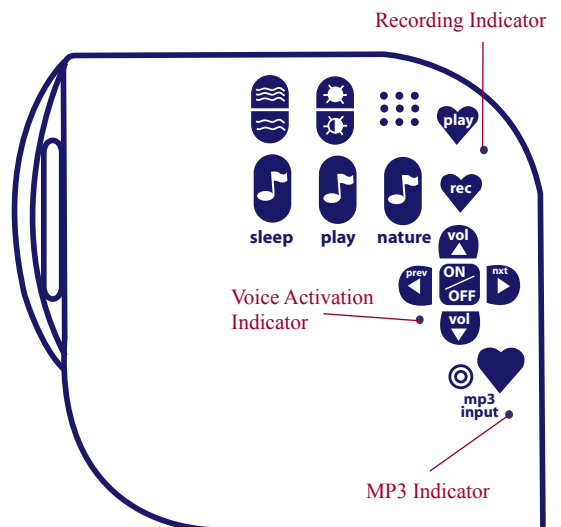

IF YOU EXPERIENCE ANY DIFFICULTY IN USING THIS PRODUCT, PLEASE CONTACT OUR CUSTOMER SERVICE DEPARTMENT AT (800) 328-7363 BETWEEN THE HOURS OF 8:00 A.M. AND 4:30 P.M. PACIFIC COAST TIME FOR ASSISTANCE.