

Model # 8836, 8869, 8878T, 8888

Trend High Chair

Instruction Manual

WARNINGS

- ⚠ WARNING:** Retain these instructions for future reference. Failure to follow these instructions could result in serious injury or death.
- ⚠ WARNING:** The tray is not designed to hold the child in the chair. The child is to be secured by the safety harness at all times while in the high chair.
- ⚠ WARNING:** Prevent serious injury or death from falls or sliding out. Always secure child in the 5-point harness system, either in the reclining, semi-reclining or upright position. The tray is not designed to hold the child in the chair. Always keep child in view while in high chair. Never leave child unattended. It is recommended that the high chair be used in the upright position only by children capable of sitting upright unassisted. See page 4 for instructions on proper use of restraint system.

- * Accessory items may change the balance of the high chair and cause hazardous unstable conditions.
- * Be certain the high chair is fully erect and latched in the open position before allowing the child near the high chair.
- * Use of the high chair with a child weighing more than 40 pounds will cause excessive wear and stress on high chair.
- * Never allow your high chair to be used as a toy.
- * To clean use only mild household soap or detergent and warm water on a sponge or clean cloth.
- * Check your high chair for loose screws, worn parts, torn material or stitching on a regular basis. Replace or repair parts as needed.
- * Discontinue use of the high chair should it malfunction or become damaged. Please contact our customer service Parts Hotline to arrange for repair or obtain replacement parts.

Please: If you experience any difficulty with the use of our product or have a question regarding these instructions, please contact our Customer Service Department at (800) 328-7363 between the hours of 8:00 am and 4:30 pm Pacific Coast Time. Please do not return to the store as once it is returned it cannot be resold and the materials and energy used to make it are wasted.

Baby Trend, Inc.
1567 S. Campus Ave.
Ontario, CA 91761

Parts Hotline:
(800) 328-7363
8:00 am and 4:30 pm Pacific Coast Time

CONTENTS

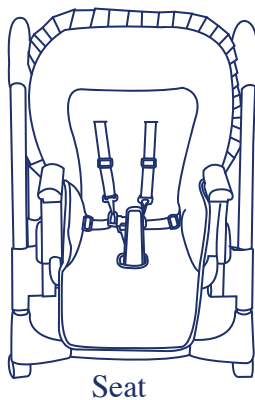

INSTRUCTIONS

TO ASSEMBLE FRAME

Carefully remove high chair from box. The high chair is shipped fully assembled except for the casters and tray. Depress the fold release buttons located on the top of the frame and push the legs apart until fully open and locked. (see Fig. 1)

⚠ WARNING: Always check that the high chair is locked in the open position before using.

TO ATTACH WHEELS

Step 1.

To attach the wheels, gently lay frame on its side.

Step 2.

Insert wheels into bottom of frame. Apply pressure until wheels feel secure (wheels do not click into place). (see Fig. 2)

Repeat for the remaining wheels.

⚠ WARNING: The tray is not designed to hold the child in the chair. The child is to be secured by the safety harness at all times while in the high chair.

TO ATTACH AND OPERATE TRAY

To attach the tray, line up the grooves on the bottom of the tray with the armrests of the high chair. Squeeze the tray release handle (see Fig. 3) and slide the tray onto the armrest (see Fig.4). The tray has a 3-position adjustment.

Depress fold release button

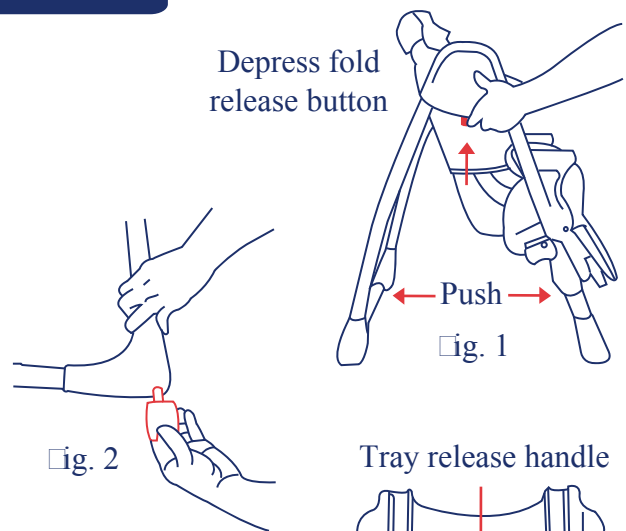

Tray release handle

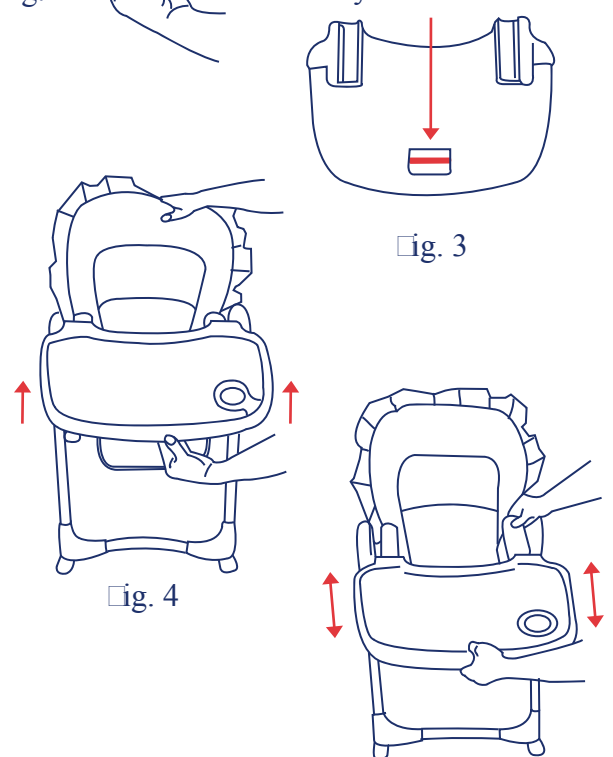

To adjust the position, squeeze the tray release handle located underneath the tray and reposition the tray to the desired position. (see Fig.5). Release tray release handle. Check that the tray is securely locked in it's new position. The dishwasher safe food tray snaps onto the high chair tray and is held in place by tabs on either side of the tray. When installing the food tray make sure that it snaps into place to prevent the child from removing the food tray. To remove the food tray, carefully lift outward on the tabs on each side.

RECLINE SEAT

Squeeze recline lever on back of the seat and adjust to the preferred recline or upright position. (see Fig.6)

⚠️WARNING: It is recommended that only children capable of sitting upright unassisted use the high chair in the upright position.

⚠️WARNING: Prevent serious injury or death from falls or sliding out. Always secure child in the restraint system, either in the reclining, semi-reclining or upright position.

TO USE SAFETY BELT

The tray is not designed to hold the child in the chair. Always keep child in view while in high chair. Never leave child unattended.

Step 1.

Place your child's arms through the loops formed by the shoulder and waist straps. Place the crotch strap between your child's legs. Insert the harness buckles into the center buckle to fasten.

Step 2.

Adjust shoulder and waist straps for your child's comfort and safety by sliding buckles in either direction. Safety straps are to fit snug around your child. (see Fig. 7)

TO RELEASE SAFETY BELT

Step 1.

Squeeze sides of buckles to release. (see Fig. 8)

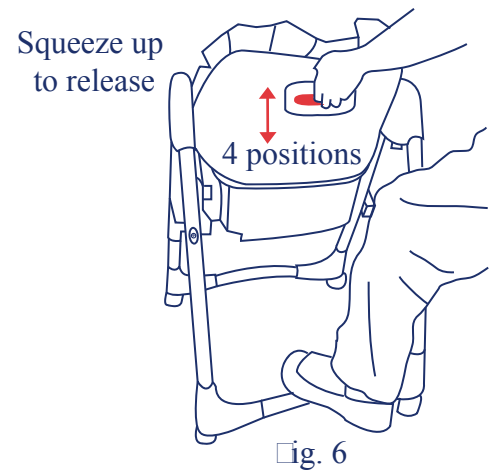

Fig. 6

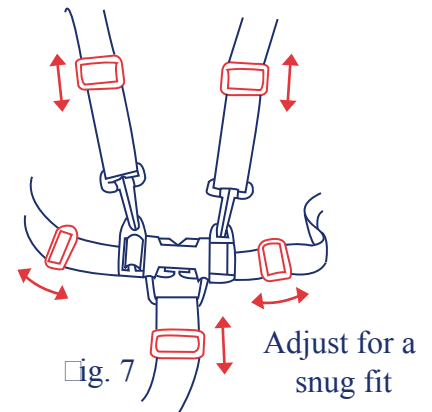

Fig. 7

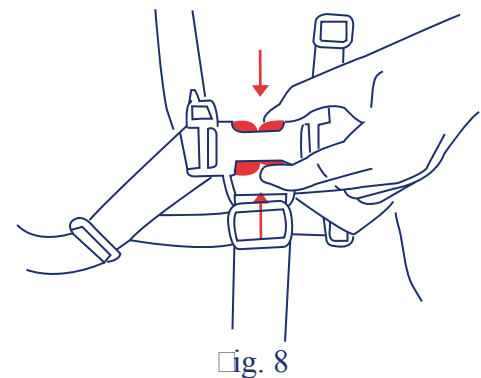

Fig. 8

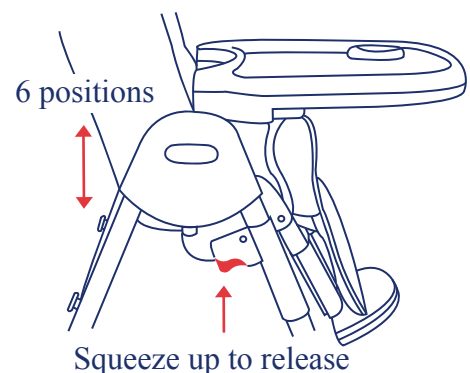

Fig. 9

⚠️ WARNING: Do not adjust seat height with child in seat. Adjust seat height before placing your child in the high chair.

TO ADJUST SEAT HEIGHT

Step 1.

Squeeze the levers on the height adjustment bracket and adjust to the ideal position. (see Fig. 9)

⚠️ WARNING: Always check that the height adjustment bracket is level and both left and right sides locked before placing child in the high chair.

TO FOLD HIGH CHAIR

The high chair may be folded with the seat in any of the height positions. The high chair will be the most compact with the seat in the lowest position, though the tray will only hang with the seat in the highest position.

Step 1.

Place seat in the desired height position (see Fig. 9).

Step 2.

Place seat back in the most upright position (see Fig. 6).

Step 3.

Squeeze the tray release handle and slide the tray out. (see Fig. 10) Hang the tray on the hooks located on the back of the rear leg. (see Fig. 11)

Step 4.

Fold up the footrest. (see Fig. 12)

Step 5.

Depress in the release buttons (located on the sides of the frame) and push the front legs in the direction of the rear legs until locked. (see Fig. 13) Chair is now ready to put away. (see Fig. 14)

TO UNFOLD HIGH CHAIR

Depress the fold release buttons located on the top of the frame and push the legs apart until fully open and locked. (see Fig. 1)

⚠️ WARNING: Always check that the high chair is locked in the open position before using.

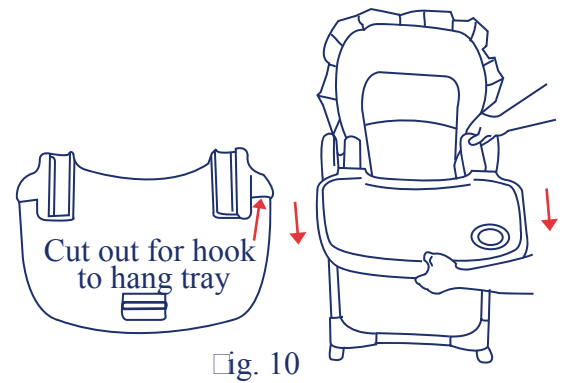

Fig. 10

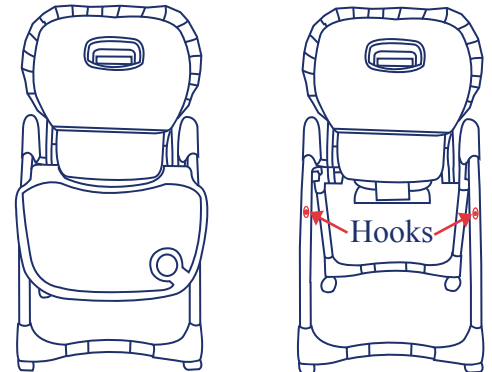

Fig. 11

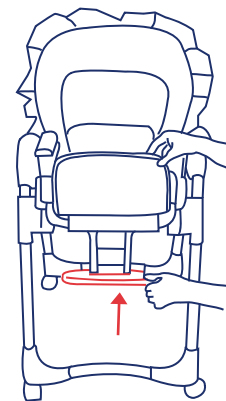
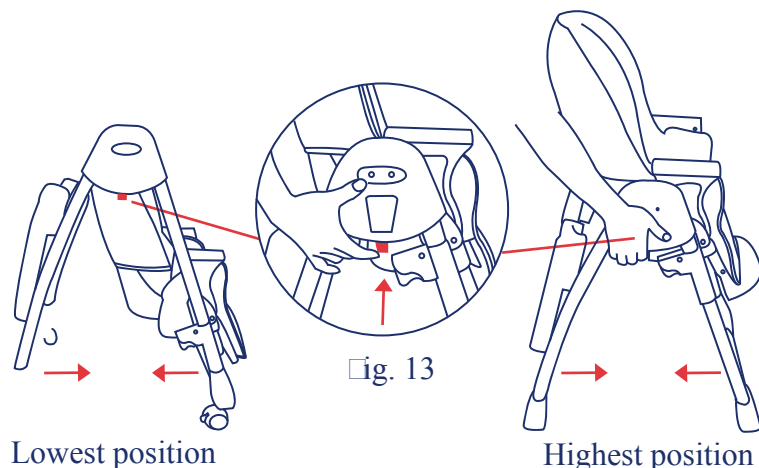

Fig. 12



Lowest position

Highest position

CARE AND MAINTENANCE

Dishwasher safe food tray:

The food tray is dishwasher safe to 160° degrees Fahrenheit. **Do not use scouring pads** on the Dishwasher food tray as they will damage the surface and the tray will become more difficult to clean.

High Chair/Tray:

Clean high chair after each use using mild household detergents. Please use only a soft bristle brush, sponge or cloth to surface clean or remove particles of food. **DO NOT** submerge high chair tray in water: Surface clean only.

To remove pad for washing:

Unsnap the shoulder straps from the waist belt buckle and push through hole in pad. Push waist belt buckles and crotch strap through holes in pad. Gently pull upward on pad to remove. Wash pad on delicate cycle using mild detergent and cold water.

Hang to dry. **DO NOT USE BLEACH.**

Replace pad and rethread safety harness in reverse order.

From time to time check your high chair for loose screws, worn parts, torn material or stitching. Replace or repair the parts as needed.

Excessive exposure to the sun or heat could cause fading, yellowing or warping of parts.

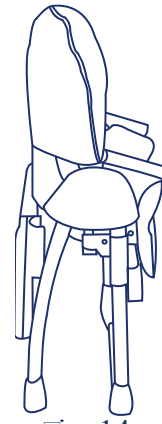

Fig. 14



IF YOU EXPERIENCE ANY DIFFICULTY IN USING THIS PRODUCT, PLEASE CONTACT OUR CUSTOMER SERVICE DEPARTMENT AT (800) 328-7363 BETWEEN THE HOURS OF 8:00AM AND 4:30PM PACIFIC COAST TIME FOR ASSISTANCE.