

Read all instructions BEFORE assembly and USE of product.  
KEEP INSTRUCTIONS FOR FUTURE USE.

# Close N Cozy

b a s s i n e t



IF YOU EXPERIENCE ANY DIFFICULTY IN USING THIS PRODUCT,  
PLEASE CONTACT OUR CUSTOMER SERVICE DEPARTMENT AT  
1-800-328-7363 BETWEEN THE HOURS OF 8:00 A.M. AND 4:30 P.M. PACIFIC  
STANDARD TIME FOR ASSISTANCE. PLEASE HAVE YOUR MODEL NUMBER AND  
MANUFACTURING DATE AVAILABLE WHEN YOU CALL.

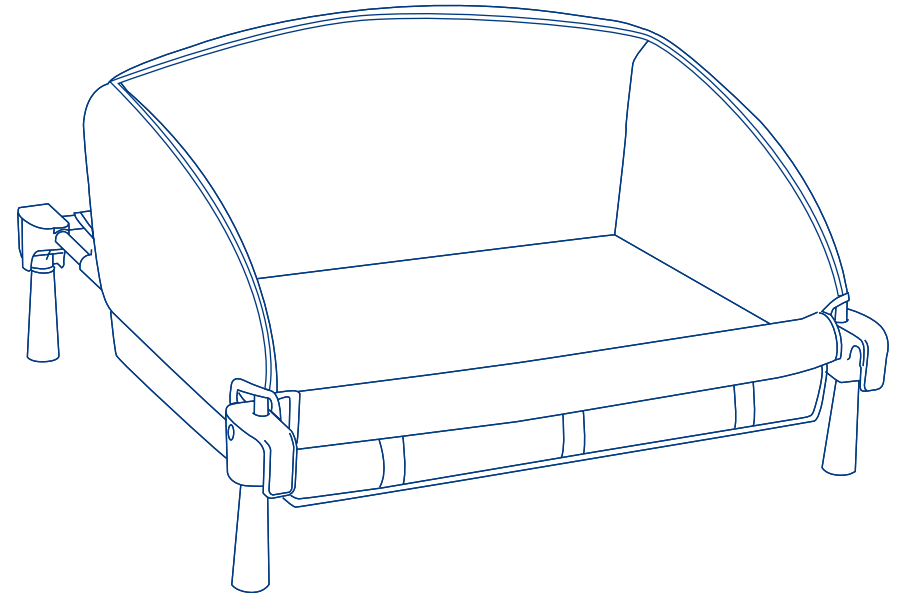

**baby trend**  
Convenience through innovation and thoughtful design

Contact us by mail:  
Baby Trend, Inc.  
1607 S. Campus Ave., Ontario, CA 91761

Contact us by phone:  
1-800-328-7363 (8:00am ~ 4:30pm PST)  
or online <http://www.babytrend.com>

Instruction Manual

**baby trend**  
Convenience through innovation and thoughtful design  
[www.babytrend.com](http://www.babytrend.com)

06.09

**⚠️ WARNING:** Failure to follow these warnings and the instructions could result in serious injury or death.

**⚠️ FALL HAZARD:** To help prevent falls, do not use this product when the infant begins to push up on hands and knees or has reached the height of 25 in. (635 mm), weight of 15 lbs. (6.8 kgs) or 4 months old, whichever comes first.

**⚠️ SUFFOCATION HAZARD:** Infants can suffocate

- In gaps between an extra pad and sides of the bassinet/cradle
- On soft bedding

Never add a mattress, pillow, comforter, or padding.

Use only the pad provided by manufacturer.

Never use a water mattress with this product.

- 
- To reduce the risk of SIDS, pediatricians recommend healthy infants be placed on their back to sleep, unless otherwise advised by your physician.
  - If a sheet is used with the pad, use only the one provided by the bassinet or cradle manufacturer or one specifically designed to fit the dimension of the bassinet or cradle mattress.
  - Strings can cause strangulation! **NEVER** place items with a string around a child's neck such as hood strings or pacifier cords. **NEVER** suspend strings over bassinet or attach strings to toys.
  - Discontinue use of the bassinet when child begins to push up on hands and knees or has reached the height of 25 in. (635 mm), weight of 15 lbs. (6.8 kgs) or 4 months old, whichever comes first.
  - **NEVER** place product near a window where cords from blinds or drapes can strangle a child.
  - Always provide the supervision necessary for the continued safety of your child. **NEVER** leave child unattended.
  - **NEVER** use plastic shipping bags or other plastic film as mattress covers not sold and intended for that purpose. They can cause suffocation.
  - Use bassinet with only one child at a time.
  - **NEVER** place a child under the bassinet.
  - **NEVER** store the bassinet in the playard while in use.
  - The bassinet must be fully assembled and installed before using.

**TYPE A:** Close N Cozy Bassinet with back basket (Part of a Nursery Center)

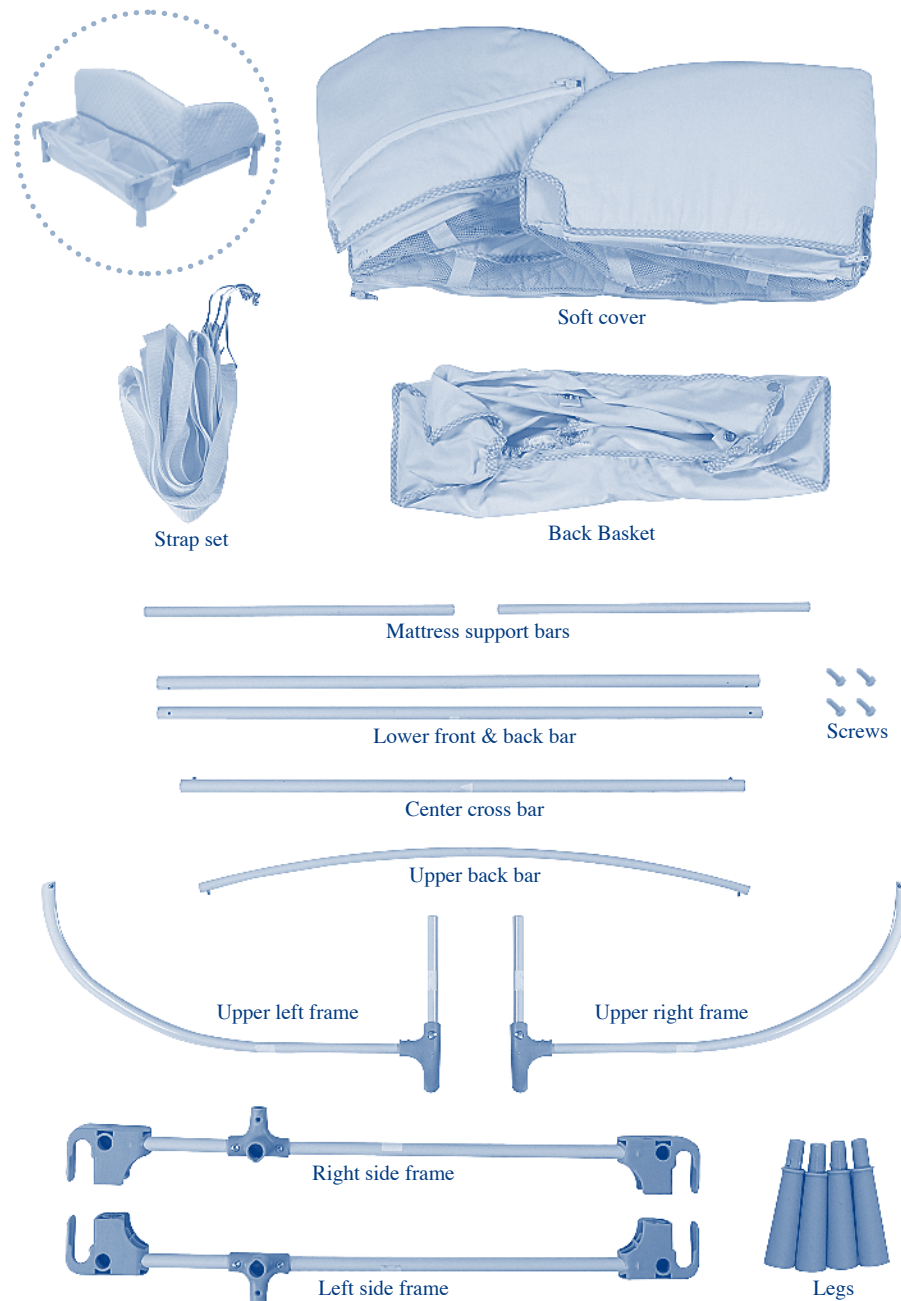

Contact us by mail:  
 Baby Trend, Inc.  
 1607 S. Campus Ave., Ontario, CA 91761

Contact us by phone:  
 1-800-328-7363 (8:00am ~ 4:30pm PST)  
 or online <http://www.babytrend.com>

**TYPE B:** Close N Cozy Bassinet with side basket (Part of a Nursery Center)

**TYPE C:** Close N Cozy Bassinet

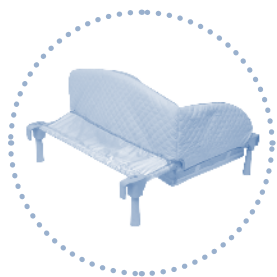

Soft cover



Strap set



Side Basket

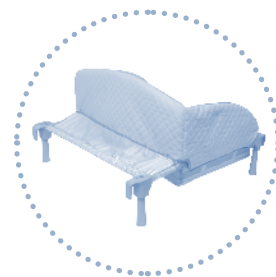

Soft cover



Strap set



Mattress



Mattress support bars

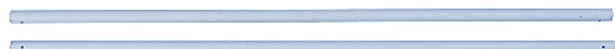

Lower front & back bar



Screws



Center cross bar

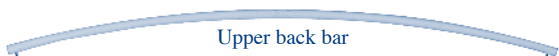

Upper back bar



Upper left frame

Upper right frame

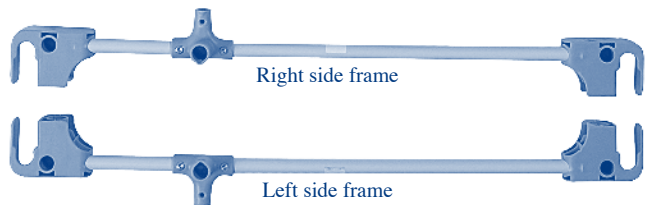

Right side frame

Left side frame



Legs



Mattress support bars

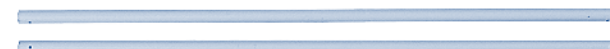

Lower front & back bar



Screws



Center cross bar



Upper back bar

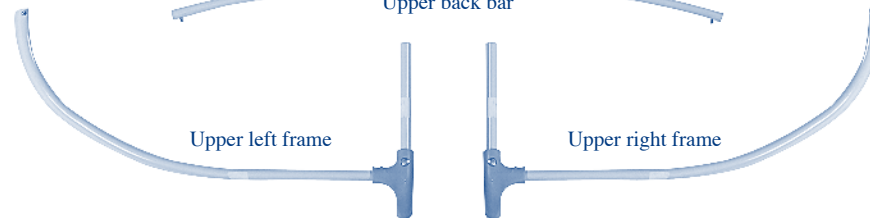

Upper left frame

Upper right frame

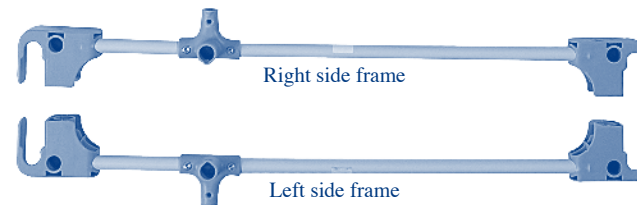

Right side frame

Left side frame



Legs

**IMPORTANT!** To ensure safe operation of your bassinet, please follow these instructions carefully. Please keep these instructions for future reference.

**IMPORTANT!** Before assembly and each use, inspect this product for damaged hardware, loose joints, missing parts or sharp edges. NEVER use if any parts are missing or broken.

**IMPORTANT!** Adult assembly is required.

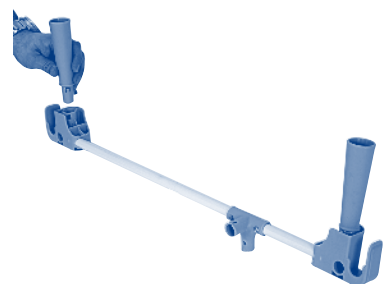

Fig. 1

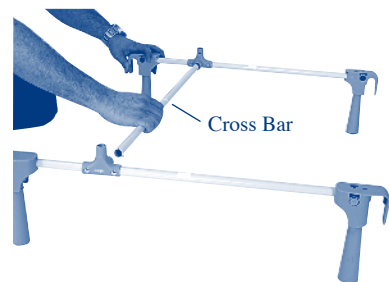

Fig. 2

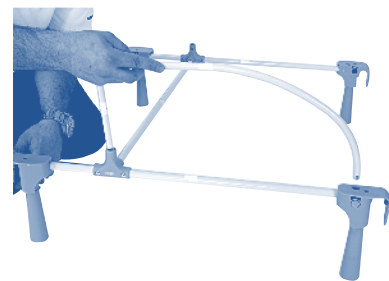

Fig. 3

## TO ASSEMBLE Close N Cozy BASSINET

**⚠️ WARNING:** This product must be fully assembled before use.

**STEP 1:** Connect the LEGS (4ea.) to the side frame corners by inserting each leg into the round hole and pushing firmly into place. (Fig. 1) Check to make sure each leg is securely connected by pulling on it.

**STEP 2:** Connect the center CROSS bar by lining up the two side frames and inserting each end of the bar into the housing. Line up snap-pins on all bars with the holes in the housing and “snap” into place. (Fig. 2)

**IMPORTANT:** Never loosely connect any parts of the frame.

**STEP 3:** Connect the upper LEFT frame section to the left side frame by inserting the bars into the housing and frame corner as shown. The snap-pin on the curved bar should be facing outward. (Fig. 3) Repeat for the other side.

**STEP 4:** Connect the upper BACK bar by lining up the snap-pins with the holes in the housings and insert into the upper left and right frame housings. (Fig. 4)

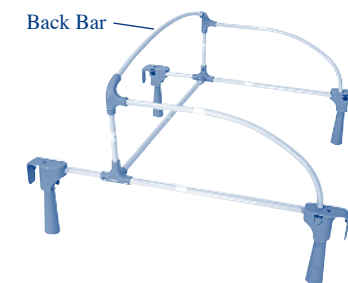

Fig. 4

**STEP 5:** Before continuing to step 5, be sure to check which type of bassinet you have.

**Type A: Soft Cover with Back Basket**  
With Back Basket in place, insert the lower BACK bar through the back panel of the soft cover. Secure the two snap flaps in place over the side frame bars. (Fig 5)

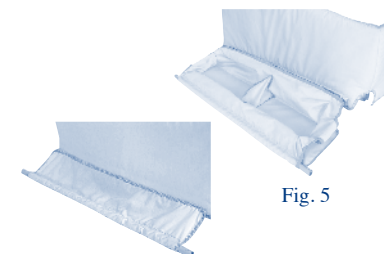

Fig. 5a

**Type B: Soft Cover with Side Basket**  
Insert the lower BACK bar through the back panel of the soft cover as shown as Fig. 5a.

**Type C: Soft Cover with Back Panel**  
Insert the lower BACK bar through the back panel of the soft cover as shown as Fig. 5a.



Fig. 6

**STEP 6:** Slip soft cover onto and over frame. (Fig. 6)

**STEP 7:** Insert the lower FRONT bar through the round, padded sleeve on the front of the soft cover. (Fig. 7)

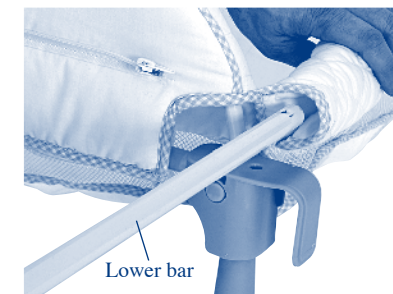

Fig. 7



Fig. 8

### STEP 8:

Connect the lower BACK to the frame corners by slightly spreading the side frames and inserting the bar into holes. Then connect the lower FRONT bar. Secure the Front and Back Bar using the screws provided. (Fig. 8)

Note: The holes in the bar and the housing must line up in order to insert the screws and properly connect.



Fig. 9

### STEP 9:

Connect the soft goods to the frame by turning the frame over and zipping closed all three (3) zippers.

### STEP 10:

Insert the mattress support bars by sliding one end of the bar through the pocket and back through the opposite side. (Fig. 9)

Note: Do not use this product without the support bars securely in place.



Fig. 10

### STEP 11:

#### For stand alone

Insert mattress and position mattress in place. (Fig. 10)

#### For playard w/Close N Cozy accessory

Using the full size playard mattress, fold in half and insert mattress with fastening strips facing front side of bassinet. Feed fastening strips through provided slots and secure the strips to velcro located on the bottom of the bassinet. (Fig. 11)

Your Close N Cozy bassinet is now ready to use.

**⚠️ FALL HAZARD: NEVER place Close N Cozy bassinet on an uneven or elevated surfaces.**



Fig. 11

**⚠️ WARNING: SUFFOCATION HAZARD: NEVER place pillows, quilts, comforters, sheepskins, pillow-like stuffed toys and other pillow like products in the Close N Cozy bassinet.**

**IMPORTANT!** Cover infant with a thin covering, such as a crib blanket, receiving blanket or other blankets specifically designed for infants, only reaching as far as baby's chest, and tuck the covering around the mattress.

## Attach Close N Cozy to playard

### ATTENTION:

Before installing Close N Cozy bassinet, remove ALL accessories from playard. (Canopy, bassinet, changing table, mobile and music box.....)

Hold Close N Cozy bassinet over playard. Line up the frame corners over the top rails of the playard and push firmly downward. Make sure all four frame corners are attached to the playard's top rails (Fig. 12).

### ATTACH SIDE BASKET TO PLAYARD

If you have Type A or Type C, skip this step.

#### Type B: Soft Cover with Side Basket

Place Close N Cozy bassinet near the playard frame corners that the changing table attaches to. Zipper side basket in place. Fold snap flap over the side of the playard and firmly secure. Snap the remaining snap flap on the Side Frame Bar (Fig. 13).

Side basket can also be attached to the playard as shown in Fig. 14.



Fig. 12



Fig. 13



Fig. 14

**IMPORTANT!** Never use this product without the anchor buckle attached and locked as shown. Failure to use this anchoring system could result in serious injury or death to the infant. Make sure all straps are secured and tight. Check straps before each use.

**IMPORTANT!** Failure to use this securing system will allow Close N Cozy to move away from adult bed and could result in infant falling out.

**IMPORTANT!** NEVER leave infant unattended.

**ATTENTION:** Before attaching Close N Cozy to playard, you must

1. Playard, including side rails, must be fully erected prior to use. **Make sure latches are secure.** Refer to playard's instruction for details.
2. Determine the height of adult bed first. Place a flat object on the top of the adult bed (including base, springs and mattress) so that a few inches of it pass over the edge of the adult bed. Measure down from this point to the floor to find the exact bed height. It is recommended to use this feature with an adult bed with floor height 24" to 30".

## Attach playard w/ Close N Cozy to bed

**⚠️ WARNING: STRANGULATION / SUFFOCATION HAZARD:** The top rail of the playard must be at or below the top of the adult bed mattress when used with Close N Cozy.

**⚠️ WARNING: STRANGULATION HAZARD:** When anchor buckle and strap assembly is not in use, store in a safe place not accessible to children.

1. Separate mattress from box spring.
2. Position Playard on the desired side of the bed.
3. With hooks positioned on the same side of the playard (Fig. 15), layout one strap set UNDER the bed frame and the other strap set ON TOP of the box spring. Fully extend both straps to the opposite side of the bed. (Fig. 16)



Fig. 15



Fig. 16

4. Attach the strap hooks to the playard legs by hooking the straps to their corresponding upper and lower positions at the front of the playard. (Fig. 17) To tighten the strap hooks, use the adjustment buckle and make sure the strap hooks stay in place while completing steps 5, 6, and 7.



Fig. 17

5. Connect the upper and lower strap sets at the opposite end of the bed by fastening the anchor buckle. (Fig. 18)
6. Position playard against the edge of the bed.
7. Secure playard against the side of the bed by tightening the straps as tight as possible. The playard must be securely positioned against the bed before use.

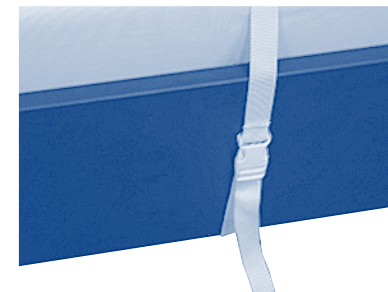

Fig. 18

Note: Set brake on Playard Wheels by pressing downward on the brake levers.

**Important:** Never use the Close N Cozy feature without the playard securely fastened to the bed.

8. Place mattress back onto box spring.

Your playard with Close N Cozy feature is now ready to use.

**⚠️ WARNING: NEVER place pillows, quilts, comforters, sheepskins, pillow-like stuffed toys and other pillow like products in the Close N Cozy bassinet.**

**⚠️ WARNING: DO NOT use full size Bassinet, Canopy, Changing Table and Mobile with Close N Cozy bassinet.**

The music center may also be attached to the rails of the Close N Cozy. (Fig. 19) When attaching the music box in this way, be sure to fasten it securely using the strap found on the back of the Close N Cozy. (Fig. 20)



Fig. 19



Fig. 20