



If you experience any difficulty in using this product, please contact our customer service department at 1-800-328-7363 between the hours of 8:00 A.M. and 4:30 P.M. Pacific Standard Time for assistance. Please have your model number and manufacturing date available when you call. This information can be found on a small sticker on the bottom of the product.



Convenience through innovation and thoughtful design

Baby Trend, Inc.  
1607 S. Campus Ave.,  
Ontario, CA 91761

1-800-328-7363  
(8:00am ~ 4:30pm PST)  
[www.babytrend.com](http://www.babytrend.com)

KEEP INSTRUCTIONS FOR FUTURE USE.

Carefully read and understand all instructions and warnings in this manual. Failure to properly use this car seat increases the risk of serious injury or death in a sudden stop or crash.

# FastBack

3-in-1 Car Seat

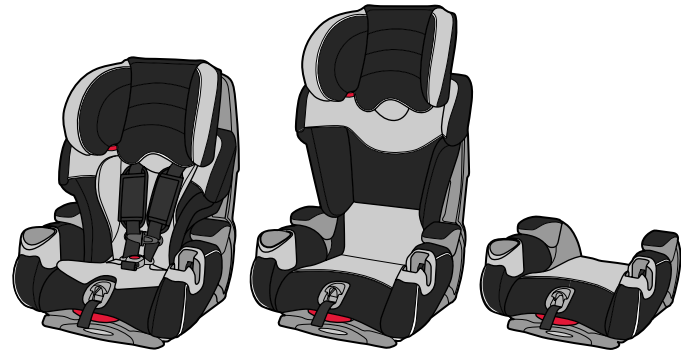

## OWNER'S MANUAL

Para instrucciones en Español, conéctese a [www.babytrend.com](http://www.babytrend.com) o llamar al: 1-800-328-7363.

FB60



[www.babytrend.com](http://www.babytrend.com)

<b>1.0 General Warnings</b> .....	<b>3</b>
<b>2.0 Registration Information</b> .....	<b>4</b>
<b>3.0 Features and Benefits</b> .....	<b>5</b>
3.1 Toddler Seat WITH Built-in Safety Harness .....	5
3.2 High Back Booster Seat WITHOUT Built-in Safety Harness .....	7
3.3 Backless Booster Seat WITHOUT Built-in Safety Harness and Back Support .....	9
<b>4.0 Preparing Car Seat for Use</b> .....	<b>11</b>
4.1 Assembling the Car Seat .....	11
4.2 Determine the Use Mode and Prepare the Car Seat .....	13
4.3 Select a Vehicle Seating Location to Install the Car Seat .....	13
4.4 Proper Use Check List .....	14
<b>5.0 Height and Weight Limitations</b> .....	<b>15</b>
5.1 Toddler Car Seat WITH Built-in Safety Harness .....	17
5.2 High-back Booster Seat WITHOUT Built-in Safety Harness .....	18
5.3 Backless Booster Seat WITHOUT Back Support .....	19
<b>6.0 Important Safety Information</b> .....	<b>20</b>
<b>7.0 LATCH</b> .....	<b>24</b>
<b>8.0 Selecting a Vehicle Seat Location</b> .....	<b>25</b>
8.1 Seat Location Requirements .....	25
<b>9.0 Vehicle Seat Belts</b> .....	<b>27</b>
9.1 SAFE Seat Belt Systems .....	27
9.2 Locking Clip Installation .....	30
9.3 UNSAFE Seat Belt Systems .....	31
<b>10.0 Securing Toddler Seat in Your Vehicle</b> .....	<b>33</b>
10.1 Installation with LATCH System .....	34
10.2 Installation with Vehicle Belt .....	38

10.2.1 WITH Vehicle Lap/Shoulder Belt .....	39
10.2.2 WITH Vehicle Lap Belt only .....	39
10.2.3 WITH Vehicle Lap Belt only, NO Tether Strap, and children under 30 lbs... ..	40
<b>11.0 Securing Child with Built-in Safety Harness</b> .....	<b>44</b>
11.1 Securing Your Child with Built-in Safety Harness .....	44
11.2 Adjusting the Crotch Strap Length .....	48
11.3 Adjusting Flex-Sides™ Back Support .....	50
<b>12.0 Securing High-Back Booster Seat in Vehicle</b> .....	<b>51</b>
12.1 Preparation for Installation .....	52
12.1.1 Remove Built-in Safety Harness .....	53
12.1.2 Built-in Safety Harness Storage .....	55
12.1.3 Reinstalling the Built-in Safety Harness .....	55
12.2 Installation with LATCH System .....	58
12.3 Installation with Vehicle Lap/Shoulder Belt .....	59
12.4 Securing Child in High-Back Booster Seat .....	61
12.5 Adjusting Flex-Sides™ Back Support and Head Support .....	62
<b>13.0 Securing Backless Booster Seat in Vehicle</b> .....	<b>64</b>
13.1 Preparation for Installation .....	66
13.2 Remove Flex-Sides™ Back Support and Head Support .....	66
13.3 Reinstalling Flex-Sides™ Back Support and Head Support .....	68
13.4 Installation with LATCH System .....	70
13.5 Installation with Vehicle Lap/Shoulder Belt .....	71
13.6 Using Shoulder Belt Positioning Clip .....	74
<b>14.0 Accessories</b> .....	<b>77</b>
14.1 Body Insert .....	78
<b>15.0 Care &amp; Maintenance</b> .....	<b>79</b>
<b>16.0 Airplane Use</b> .....	<b>80</b>

## WARNINGS TO PARENTS AND CAREGIVERS

The ultimate safety of your child depends on the proper and secure installation of the Car Seat in your vehicle. Proper installation requires that you read and understand this entire manual and your vehicle's owner's manual before placing your child in the seat. **DO NOT** allow others to install or use this Car Seat unless they completely understand its proper installation and use.

Even if using this Car Seat seems easy to figure out on your own, it is very important to follow all instructions on this Car Seat and in the written instructions. **READ THIS OWNER'S MANUAL** and the vehicle owner's manual.

Failure to properly use this Car Seat can result in serious injury or death from a crash, sharp turn or sudden stop. Your child's safety depends on you installing and using this Car Seat correctly. Use this Car Seat **forward-facing only**.

**Your child's safety depends on you:**

- **Choosing the correct mode of use** for your child's height and weight.
- **Choosing the best location** for the Car Seat in your vehicle.
- **Properly routing the vehicle seat belt or LATCH.**
- **Properly securing the Car Seat in the vehicle** by using LATCH or using a seat belt designed to retain both the Car Seat and your child. Proper use and routing of the seat belts in your vehicle is essential for proper installation. Many vehicle seat belts are NOT safe to use with this Car Seat.
- **Properly securing your child** in the child restraint.

## REGISTER YOUR CAR SEAT

Please complete the following information. The model number and manufactured in (date) can be found on a label on the bottom of the Car Seat.

Model Number: \_\_\_\_\_

Manufactured in: \_\_\_\_\_

Purchase Date: \_\_\_\_\_

Please fill out the prepaid registration post card attached to the safety harness and mail it today.

Child restraints could be recalled for safety reasons. You must register this restraint to be reached in a recall. Send your name, address, email address if available, and the restraint's model number and manufacturing date to: **Baby Trend, Inc., 1607 S. Campus Avenue, Ontario, CA 91761** or call **1-800-328-7363** or register online at: <http://www.babytrend.com/registration.html>. For recall information, call the **U.S. Government's Vehicle Safety Hotline at 1-888-327-4236** (TTY: 1-800-424-9153), or go to <http://www.NHTSA.gov>.

### If You Need Help

Please contact our Customer Service Department with any questions concerning your child restraint. When you contact us, please have the model and manufactured in (date) ready. These numbers can be found on a white label located on the bottom of the child restraint.

USA Toll Free: **1-800-328-7363**

8:00 a.m. to 4:30 p.m. (PST) Monday - Friday  
or [www.babytrend.com](http://www.babytrend.com)

## 3.1 Toddler Seat WITH Built-in Safety Harness

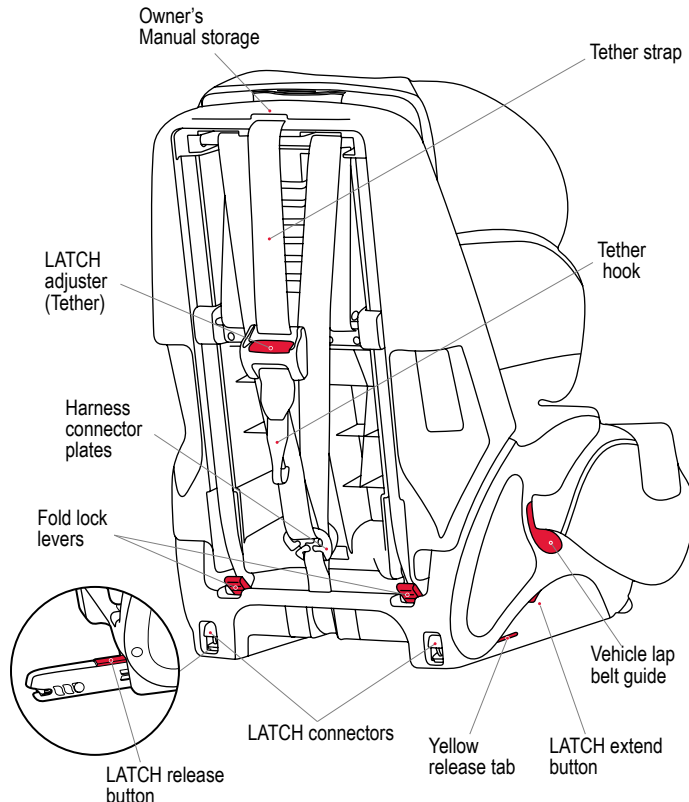
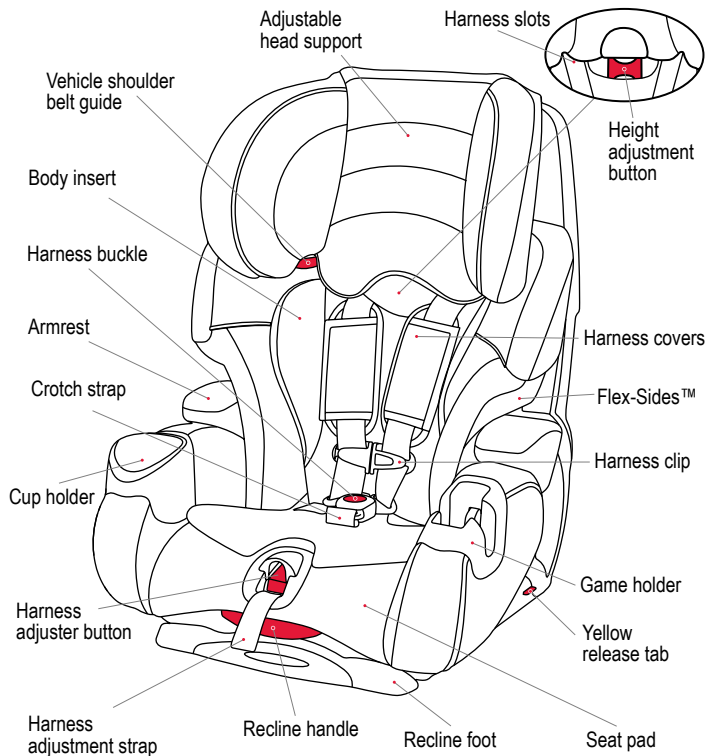

#### 3.2 High Back Booster Seat WITHOUT Built-in Safety Harness

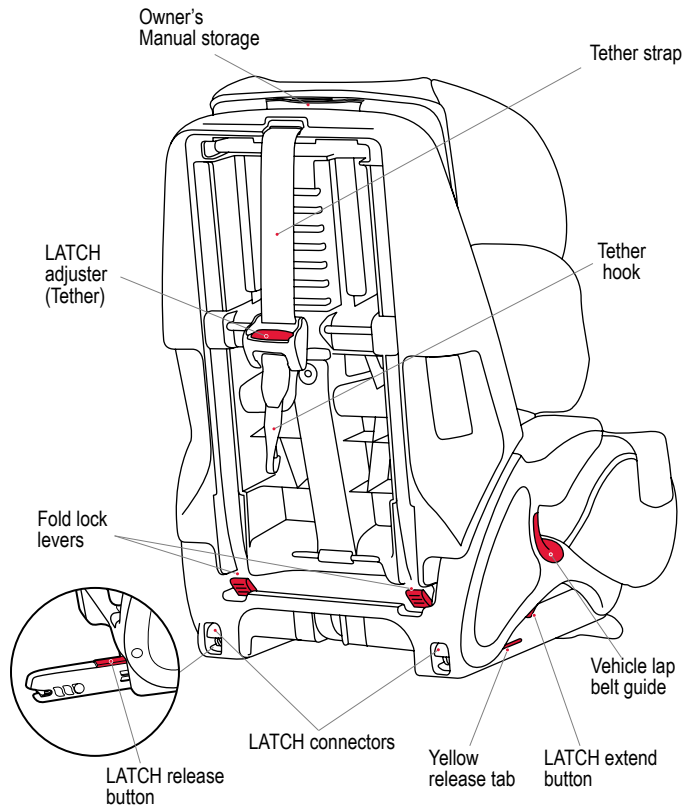
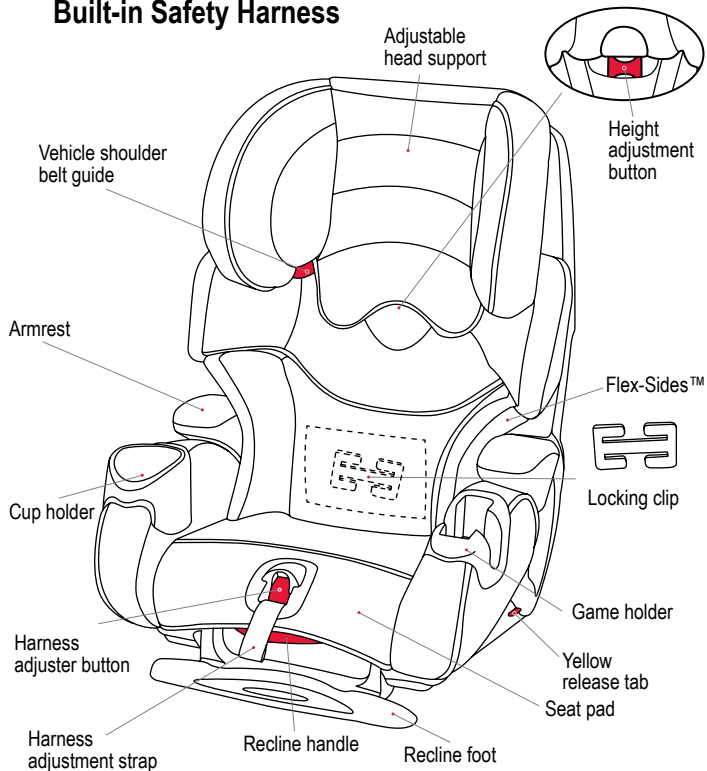

#### 3.3 Backless Booster Seat WITHOUT Built-in Safety Harness and Back Support

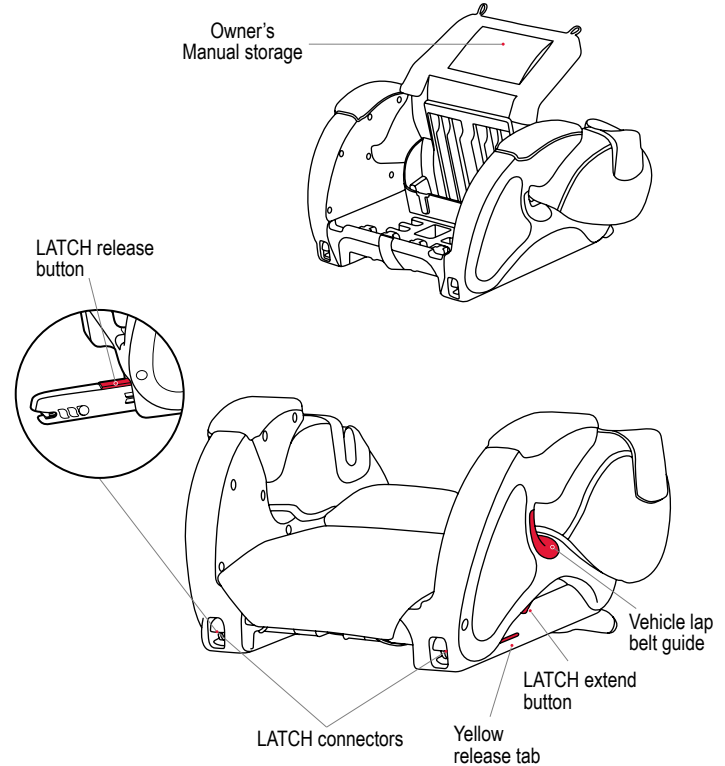
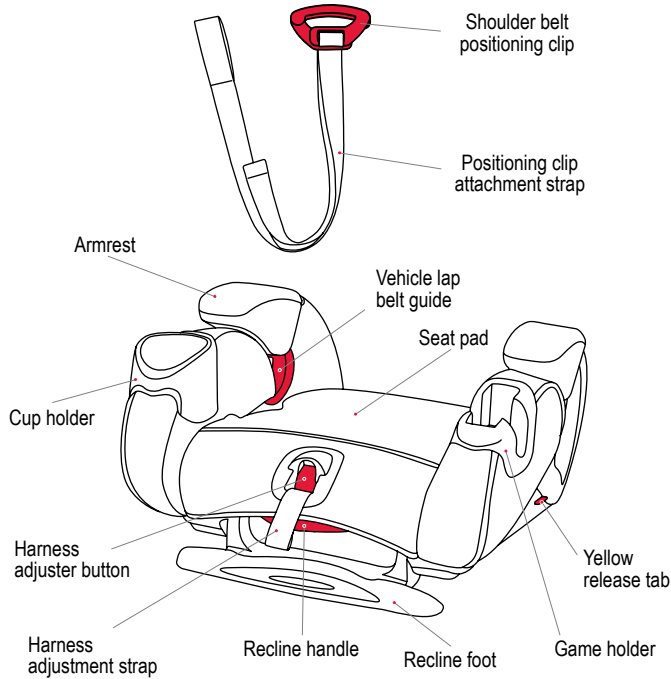

## 4.1 Assembling the Car Seat

ADULT SET UP REQUIRED.

**WARNING**

**PREVENT INJURY FROM PINCHING – KEEP FINGERS CLEAR OF HINGES WHEN ROTATING BACK SUPPORT UP INTO USE POSITION. KEEP CHILDREN AWAY FROM CAR SEAT DURING SET UP AND ADJUSTMENT.**

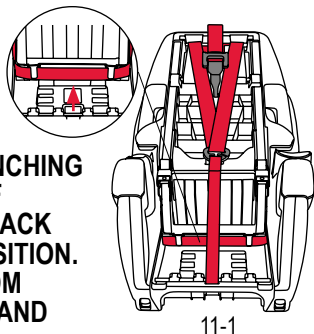

11-1

Check to make sure that all parts and harness belts are properly in place. (Fig 11-1)

While pulling Harness Adjustment Strap away from seat, lift and unfold back support until it locks into place.

Note: You should hear a “click” when the locks are fully engaged. (Fig 11-2) Always confirm that both Fold Lock Levers are engaged before use.

Check to make sure that the Harness Adjustment Strap is not trapped inside the seat as shown. (Fig 11-3)

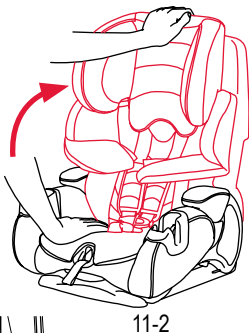

11-2

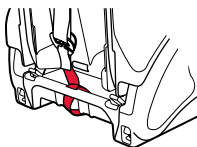

11-3

Raise the adjustable seat back to the highest position by pressing in on the Height Adjustment Button and lifting upward on seat back. (Fig 12-1)

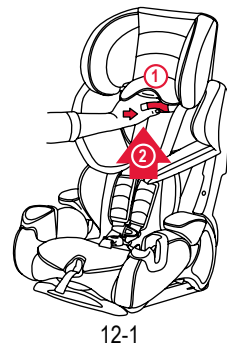

12-1

Unfold the Flex-Sides™ down and fasten in place using the Velcro® strips on the rear of the seat back fabric and Flex-Sides™. (Fig 12-2)

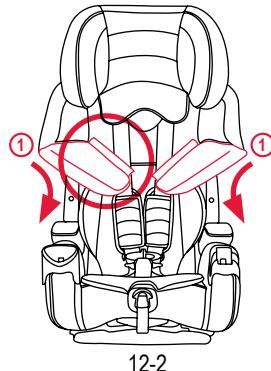
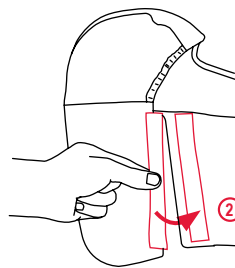

12-2

### 4.2 Determine the Use Mode and Prepare the Car Seat

#### Toddler Car Seat WITH Built-in Safety Harness “between 22 and 70 lbs” (10 and 31.7 kg)

- Use Body Insert with smaller child.
- Harness strap height must be at or above child's shoulder.
- Adjust the harness strap height to fit your child

#### High-back Booster Car Seat WITHOUT Built-in Safety Harness “between 30 and 100 lbs” (13.6 and 45.3 kg)

- Remove the harness system for Booster Car Seat Use
- Remove Body Insert.
- Adjust back support for your child
- Adjust head support for your child

#### Backless Booster Car Seat WITHOUT Built-in Safety Harness “between 40 and 120 lbs” (18.1 and 54.3 kg)

- Remove Back Support

Note: See Weight and Height Limitations section for more information

### 4.3 Select a Vehicle Seating Location to Install the Car Seat

#### WITH Built-in Safety Harness

- Select a vehicle seating location with a tether anchor, if available. Baby Trend requires using the tether for installation whenever possible.

#### Booster Seat Mode WITHOUT Built-in Safety Harness

- Select a vehicle seating location with a lap/shoulder belt.
- Never use a vehicle seating location with only a lap belt.

Note: See section 8.0 **Selecting a Vehicle Seat Location** for more information

### 4.4 Proper Use Check List

#### Toddler Car Seat (WITH Built-in Safety Harness)

- ✓ Car seat is securely installed in vehicle.
- ✓ The correct belt routing for installation is used based on use of tether.
- ✓ Top Tether is used, when possible.
- ✓ Harness straps are in harness slots at or above child's shoulders.
- ✓ Harness is snugly adjusted around child.

#### Booster Car Seat (WITHOUT Built-in Safety Harness)

- ✓ Lap and shoulder belts are snugly adjusted around child.
- ✓ Lap belt is low and flat on hips and contacting thighs.
- ✓ Shoulder belt is centered on shoulder.
- ✓ Child is sitting up, not slouching down under vehicle lap belt.
- ✓ Shoulder belt is not under arm or behind back of child.
- ✓ Top of child's ears are below top of vehicle seat back or vehicle headrest.

**! WARNING!**

**DEATH or SERIOUS INJURY can occur:**

**FAILURE TO USE CHILD RESTRAINT IN A MANNER APPROPRIATE FOR YOUR CHILD'S SIZE MAY INCREASE THE RISK OF SERIOUS INJURY OR DEATH.**

Instructions for the use of this Car Seat differ greatly depending on the size of your child. Be sure you are using the Car Seat in the correct mode and with the correct features for your child.

### Car Seat Use Modes

This Car Seat has three different use modes for the weight and height ranges listed below and depends on the size of your child. Instructions for the proper use of this Car Seat differ greatly for each use mode. Be sure you are using the Car Seat in the correct mode and with the correct features for your child as identified in this owner's manual.

- 1. Toddler Car Seat (WITH Built-in Safety Harness)** For children weighing between 22 and 70 lbs (10 and 31.7 kg).



- 2. High-back Booster Seat (WITHOUT Built-in Safety Harness)** For children weighing between 30 and 100 lbs (13.6 and 45.3 kg).



- 3. Backless Booster Seat (WITHOUT Built-in Safety Harness and back support)** For children weighing between 40 and 120 lbs (18.1 and 54.3 kg).



### 5.1 Toddler Car Seat WITH Built-in Safety Harness

Your child must meet **ALL** these requirements:

- Weight between 22 and 70 lbs (10 and 31.7 kg)
- Height between 28.5 and 52 inches (72 and 132 cm)
- At least one year old and can sit upright unassisted
- Top of child's shoulders are at or **BELOW** harness slots in highest adjustment position



Note: If child's shoulders are above the harness slots when adjusted to the highest position, child is too large to use Built-in Safety Harness.

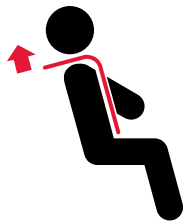

### 5.2 High-back Booster Seat WITHOUT Built-in Safety Harness

Your child must meet **ALL** these requirements:

- Weight between 30 and 100 lbs (13.6 and 45.3 kg)
- Height between 38 and 57 inches (96 and 145 cm)
- Approximately 3-10 years of age
- The shoulder belt **MUST** lie across child's shoulder as shown and the lap portion of the belt is positioned low on the child's hips
- Child's ears are **BELOW** top of the booster seat



Note: If the tops of the ears are above the top of the seat, then the child is too large for the booster seat.

Parents are advised that the back support and head support of the high-back booster car seat provide incremental crash protection in frontal and side impact crashes. Removing the back support and head support earlier than necessary also removes the incremental crash protection.

**We highly recommend using the built-in safety harness for as long as possible when the child is 70 lbs or less and the shoulders are below the harness slots in the highest position.**

### 5.3 Backless Booster Seat WITHOUT Back Support

Your child must meet **ALL** these requirements:

- Weight between 40 and 120 lbs (18.1 and 54.3 kg)
- Height between 42 and 57 inches (107 and 145 cm)
- Approximately 4-10 years of age
- The Shoulder belt **MUST** lie across child's shoulder as shown and the lap portion of the belt is positioned low on the child's hips
- Top of child's ears must be below top of vehicle seat back or vehicle headrest



Baby Trend and the American Academy of Pediatrics recommend using a Backless Booster Car Seat until the child reaches a standing height of 57 in. (145 cm) before changing to secure the child with a vehicle seat belt, without a booster car seat.

## **! WARNING!**

**DEATH or SERIOUS INJURY can occur:**

**TO AVOID INJURIES FROM WHIPLASH, TOP OF CHILD'S EARS MUST BE BELOW TOP EDGE OF VEHICLE SEAT BACK OR VEHICLE HEADREST.**

## **! WARNING!**

**DEATH or SERIOUS INJURY can occur:**

Failure to follow these instructions and Car Seat labels can result in child striking the vehicle's interior during a sudden stop or crash.

- Use this Car Seat only with children who weigh between 22 and 120 lbs (10 and 54.3 kg) and whose height is between 29 and 57 in. (74 and 145 cm) and who are capable of sitting upright unassisted.
- Child must be at least 1 year old and 22 lbs (10 kg) to use this Car Seat.
- Proper installation of the Car Seat in your vehicle and proper securing of your child in the Car Seat are essential to ensure the safety of your child. Your child can be injured in a sudden stop or crash if not properly secured in the Car Seat or if the Car Seat is not properly installed in the vehicle.
- Use this Car Seat forward-facing only with child facing the front of the vehicle.
- Toddler Use Mode:
  - Secure this child restraint with the vehicle's Child Restraint Anchorage System (LATCH) if available or with a vehicle belt.
  - Secure Tether Strap provided with this child restraint.
  - Always use proper belt routing based on tether use.
  - Always use Harness Covers.
  - Snugly adjust harness around child.
  - Adjust harness strap height to child's shoulder height.
  - Use Body Insert for smaller child.

### • **Booster Use Mode:**

- Use only with children that are 3 years old and weigh at least 30 lbs (13.6 kg).
  - Snugly adjust the vehicle's lap/shoulder belt around child.
  - Properly position the vehicle's lap/shoulder belt on child. Lap belt is low on child's hips and contacting thighs and shoulder belt is centered on shoulder.
  - Use only the vehicle's lap/shoulder belt system to restrain a child.
  - Never use only a lap belt to secure child in the Booster Car Seat.
  - Use back support as long as possible.
  - Never use Body Insert when using Booster Car Seat.
- **Never leave your child unattended, even for a moment.**
  - **Never put a Car Seat in a vehicle front seat location unless specifically recommended in vehicle owner's manual.**
  - **Never use this Car Seat in a vehicle seating location that has an Active Air Bag unless recommended in the vehicle owner's manual. If your vehicle is equipped with a front passenger side Active Air Bag, please refer to the vehicle's owner's manual for additional information about Active Air Bags and child safety seat installation.**
  - **This Car Seat is designed and tested to accommodate a child of a specific range of WEIGHT and HEIGHT. Using the Car Seat for a child whose weight or height is outside of these limits will increase the risk of death or serious injury in the event of a crash (see Section 5.0 of this manual for WEIGHT and HEIGHT limits for this car seat).**

- **DO NOT dress your child in bulky clothing or other garments that will hinder the harness from being properly latched between your child's legs and belts being snugly adjusted around your child.**
- **Not all vehicle seat belts or seating locations can be used with this Car Seat. Read vehicle owner's manual and "Vehicle Seat Belts" section in this manual.**
- **Some vehicles do not have any safe location for this Car Seat to be installed. In addition, many vehicles do not have seat belt systems that will adequately hold this Car Seat in the required position. Please refer to both this manual and your vehicle owner's manual for complete information for proper, safe installation of this Car Seat.**
- **This Car Seat is certified for use in motor vehicles and for use on aircraft in Toddler Car Seat use mode. DO NOT use this Car Seat in the home, on boats or other non-certified applications.**
- **DO NOT use accessories or parts other than those provided by Baby Trend, Inc. Use of accessories or parts from other manufacturers could alter the performance and safety of the Car Seat. The Car Seat may become very hot if left in direct sunlight. Your child may suffer burns from hot components. Always check the Car Seat for hot surfaces that may come into contact with your child before placing your child in the Car Seat. We suggest that you cover the Car Seat with a blanket or towel if it will be subject to direct sunlight while you are away from the vehicle.**
- **This Car Seat is constructed of plastic that can deform over time if left with any object in the seat while stored. DO NOT leave heavy objects in the Car Seat while not in use. DO NOT**

store the seat in the trunk of your car with heavy objects on it or with pressure on the Car Seat from the trunk lid.

- Discontinue use of the Harness System and Back Support after 6 years and the Booster Seat Base after 9 years from the date of manufacture printed on the label on the bottom of the Seat Base.
- **DO NOT** use Car Seat if it has been in a crash, it must be replaced. A crash can cause unseen damage and using it again could result in serious injury or death.
- **DO NOT** use Car Seat if it is damaged or is missing parts.

No car seat can guarantee protection from injury in every situation, but proper use helps reduce the risk of serious injury or death.

## LATCH

 Lower Anchors and Tethers for Children (**LATCH**) System is designed to make installation of child safety seats easier by requiring child restraints to be installed without using the vehicle's seat belt system. Since September 1, 2002, two rear seating positions of all cars, mini vans and light trucks come equipped with lower child restraint anchor points located between a vehicle's seat cushion and seat back. Also on September 1, 2002, all child restraints will have two attachments which will connect to the vehicle's lower anchor points. Together, the lower anchors and upper tethers make up the **LATCH** system. **Read your vehicle owner's manual for exact locations, identification and requirements for use with a child restraint.**

**ONLY** use **LATCH** to secure your child restraint in a seating position recommended by the vehicle manufacturer.

Refer to the vehicle owner's manual for the vehicle's top tether anchor locations. They should be identified by one of the symbols shown in Fig. 24-1.

**IMPORTANT:** With children weighing more than 50 pounds (23 kg) use vehicle belt (**NOT LATCH**) for installations. It is important to note that some vehicle manufacturers have lower weight rating for **LATCH** anchors. Consult your vehicle owner's manual or contact the vehicle manufacturer for limits on your vehicle's **LATCH** anchors.

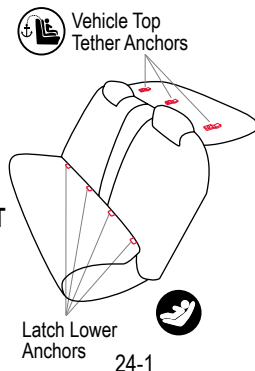

## SELECTING THE BEST VEHICLE LOCATION

### **! WARNING!**

**DEATH or SERIOUS INJURY can occur:**

**IMPROPER PLACEMENT OF THE CHILD RESTRAINT INCREASES THE RISK OF SERIOUS INJURY OR DEATH.**

Not every location within a vehicle may be safe for the installation of this Car Seat. In fact, some vehicles have no seating position that is safe for the installation of a Car Seat. Improper placement of this Car Seat within a vehicle will increase the risk of death or serious injury.

Please follow the instructions in this manual and in your vehicle owner's manual carefully to ensure proper location and installation of this Car Seat. If you are uncertain about the proper location of the Car Seat within the vehicle, contact your vehicle manufacturer directly or through their dealer before using this Car Seat.

### 8.1 Seat Location Requirements

According to accident statistics, children are safer when properly restrained in rear vehicle seating positions, rather than front seating positions. Whenever possible, this Car Seat should be secured in the rear center, seating position. The rear seat directly behind the front seats **NOT** in a third row rear seat. (Fig 25-1) However, this position sometimes is equipped with a



25-1

vehicle lap belt only and **CANNOT** be used when this Car Seat is used as a booster seat **WITHOUT** the Built-in Safety Harness.

**ONLY** place in a forward-facing vehicle seat. **DO NOT** place this Car Seat in any vehicle seat that faces to the rear or to either side of the vehicle. (Fig 26-1)



26-1

Car Seat **MUST NOT** hang over the front edge of the vehicle seat. (Fig 26-2)



26-2

**NEVER** place this Car Seat in a vehicle seating location that has an Active Frontal Air Bag! Active Frontal Air Bags inflate with great force! An inflating Active Frontal Air Bag can strike a Car Seat with enough force to cause death or serious injury to your child. (Fig 26-3)



26-3

## VEHICLE SEAT BELT REQUIREMENTS

### **! WARNING!**

**DEATH or SERIOUS INJURY can occur:**

**THE CAR SEAT MUST BE TIGHTLY SECURED AT ALL TIMES. THE VEHICLE SEAT BELT MUST BE CAPABLE OF MAINTAINING A TIGHT INSTALLATION AT ALL TIMES. A VARIETY OF VEHICLE SEAT BELT SYSTEMS HAVE BEEN INSTALLED ON VEHICLES THAT ARE NOT SAFE FOR USE WITH THE CAR SEAT.**

Even newer vehicles can have seat belts systems that are **NOT** safe for use with the Car Seat. These systems may look safe but their method of operation precludes their use with the Car Seat. If you are unsure if the vehicle seat belt is safe for use with the Car Seat, check the vehicle owner's manual or contact the vehicle manufacturer, or your vehicle dealer for additional information.

### 9.1 SAFE Seat Belt Systems

The following vehicle seat belt systems can be used with the Car Seat provided that all of the other requirements prescribed in these instructions, including seat position, and all instructions provided by your vehicle owner's manual are followed.

## USING BUILT-IN SAFETY HARNESS ONLY:

### Lap Belts (Manually Adjusted)

A lap belt that is manually adjusted and will remain tightly adjusted around the Car Seat while the vehicle is in motion is suitable for use with the Car Seat. Pulling the belt through the buckle after the buckle is fastened tightens this type of seat belt. (Fig 28-1)

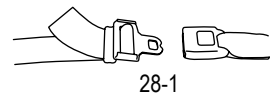

28-1

### Lap Belts with Automatic Locking Retractor (ALR)

A lap belt that cannot be lengthened once it is fastened is suitable for use with the Car Seat. These seat belts often have an automatic locking retractor (ALR) that will allow the belt to be lengthened but once fastened, must be unbuckled and allowed to retract fully before allowing the belt to be lengthened again. (Fig 28-2)

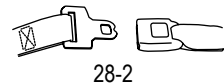

28-2

## WITH or WITHOUT BUILT-IN SAFETY HARNESS:

### Combination Lap/Shoulder Belt with Locking Latch Plate

A lap/shoulder combination seat belt with a latch plate that locks the lap belt into position

is suitable for use with the Car Seat. Once this type of seat belt is fastened, the latch plate prevents the lap belt from loosening. This combination seat belt does not require a Locking Clip. (Fig 29-1)

Note: The belt is tightened by pulling hard on the shoulder belt while pushing down hard on the Car Seat.

### Combination Lap/Shoulder Belt with Sliding Latch Plate

A lap/shoulder combination belt system with a latch plate that can slide freely along the belt (Fig 29-2) is suitable for use with the Car Seat if it includes a lockable retractor or a Locking Clip (Fig 29-3) **MUST** be used to secure the lap belt into position to prevent loosening. Use the Locking Clip provided with the Car Seat as instructed (See section 9.2).

**Please refer to your vehicle owner's manual for additional information on locking this style of seat belt.** This style of belt **MUST** be locked to prevent movement of the Car Seat.

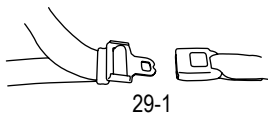

29-1

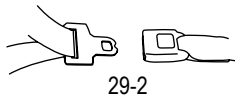

29-2



Locking clip

29-3

## 9.2 Locking Clip Installation

### **! WARNING**

**DO NOT USE LOCKING CLIP IN BOOSTER SEAT MODE.**

Locking Clip is located in the pocket on underside of Seat Pad. (Fig 30-1)

1. Tighten the buckled seat belt around the Car Seat by pulling upward on the shoulder belt while pushing down hard on the Car Seat.
2. While maintaining downward pressure on the Car Seat, squeeze the shoulder belt and lap belt together just above the buckle to prevent it from moving. Unbuckle the seat belt, being careful to prevent movement of the buckle.
3. Secure the shoulder belt to the lap belt by installing the Locking Clip 1/2" from the buckle. (Fig 30-2)
4. Re-buckle the seat belt and check that the seat belt is very tight around the Car Seat. Pull firmly on the lap belt to ensure that the Locking Clip is locking the lap belt and remains very tight.

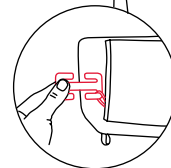
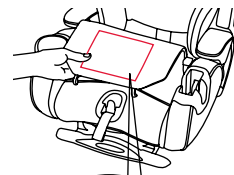

30-1

1/2" (1.25cm)

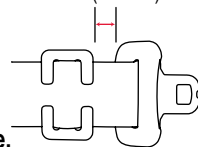

30-2

**Test installation to make sure Car Seat is secure. If NOT secure, additional belt tightening is required. Repeat steps above until secure.**

### 9.3 UNSAFE Seat Belt Systems

**DO NOT** use the following types of seat belt systems with the Car Seat. These belt systems will not hold the Car Seat securely in place at all times. In addition, the Locking Clip provided with this product will **NOT** make these belt systems safe to use. **NEVER USE** unsafe vehicle belts systems!

Note: **LATCH** can be used **IN PLACE OF** the following unsafe vehicle seat belts systems if your vehicle is equipped with **LATCH** anchorage system.



#### Lap Belts with Emergency Locking Retractor (ELR)

**DO NOT** use a lap belt that stays loose after installed and locks only in a crash or sudden stop. These lap belts utilize an Emergency Locking Retractor (ELR) and are often found in combination with motorized shoulder belts. Because these belts will allow the Car Seat to move about on the vehicle seat, the chance of the Car Seat being out of the proper position in a crash is very high. Accordingly, **DO NOT** use the Car Seat with this type of seat belt system. Please see your vehicle's dealer or owner's manual for information on converting this seat belt system to one that is acceptable for use with a Car Seat. (Fig 31-1)



31-1



31-2

#### Combination Lap/Shoulder Belt with Retractor

**DO NOT** use a lap/shoulder belt system if the lap belt and shoulder belt each have retractors

at one end. This type of seat belt system will not adequately restrain the Car Seat. (Fig 31-2)

#### Passive Restraint – Lap or Shoulder Belt Mounted on Door

**DO NOT** use a seat belt that is connected to the door in any way. These types of seat belts are designed to automatically surround the occupant when the door is closed. This type of seat belt will **NOT** adequately restrain the Car Seat. (Fig 32-1)

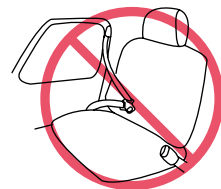

32-1

#### Passive Restraint – Lap Belt with Motorized Shoulder Belt

**DO NOT** use a shoulder belt that moves along a track. These systems typically move to surround the occupant when the door is closed. This type of belt system will **NOT** adequately restrain the Car Seat. (Fig 32-2)



32-2

#### Lap Belts Forward of Seat Crease

**DO NOT** use a seat belt that is anchored on the seat more than 2 inches forward of the crease between the seat bottom and the seat back. This type of seat belt anchors the Car Seat too far forward and the Car Seat will not be safely restrained in the vehicle. (Fig 32-3)



32-3

**INSTALLATION WITH BUILT-IN HARNESS****⚠ WARNING!**

**DEATH or SERIOUS INJURY can occur:**

**FAILURE TO PROPERLY SECURE THE CHILD RESTRAINT IN YOUR VEHICLE INCREASES THE RISK OF SERIOUS INJURY OR DEATH IN THE EVENT OF A SUDDEN STOP, SHARP TURN OR CRASH.**

- Proper installation is required.
- The belt routing for securing this Car Seat in a vehicle is dependent on installation WITH or WITHOUT the Top Tether.
- Secure this child restraint with LATCH System or vehicle seat belt and Top Tether Strap as shown in this manual.
- LATCH or vehicle seat belt must stay tightly adjusted around Car Seat at all times.
- Vehicle seat belt must be routed through Back Support of Car Seat when using harness system.
- Snugly adjust harness provided with the Car Seat around child.
- Harness straps must be through harness strap slots at or above child's shoulders.
- Never place vehicle seat belt in front of child when using harness system.

- Only use the car seat LATCH System in vehicle seating positions designated by the vehicle manufacturer as LATCH use position and have anchor spacing of 11 inches (280 mm).
- The car seat must be held tightly by the LATCH System.
- Never attach more than one top tether hook to a vehicle anchorage unless recommended in the vehicle owner's manual.

Your child restraint can be installed with either LATCH or with a SAFE vehicle belt system. To properly install the child restraint and protect your child, you must carefully follow these instructions.

**10.1 Installation with LATCH System**

The LATCH system is made up of the two lower child restraint anchorages and a top tether anchor anchorage. When available, LATCH is the recommended method of securing the Car Seat in the vehicle.

- Locate a LATCH seating position and locate the LATCH anchorages in the vehicle seat. (See Section 7.0 LATCH for more information)  
The LATCH System when used with top tether, may be used to 50 lbs (23 kg). Over 50 lbs (23 kg), disconnect LATCH and secure with a vehicle seat belt.
- If vehicle seat back is adjustable, adjust into the upright position or the position or the position specified in the vehicle owner's manual for use with a Car Seat.

- Lengthen the Tether Strap and place over top of headrest and into seat. (Fig 35-1)

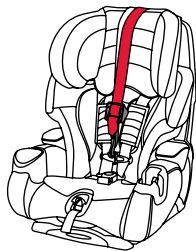

35-1

## Attach the Lower LATCH Connectors

1. Extend the LATCH Connectors by pressing the LATCH Extend Button on each side as shown. (Fig 35-2)

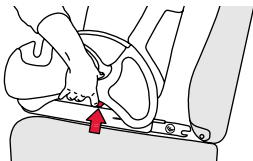

35-2

2. Secure the LATCH Connectors to the vehicle LATCH lower anchorages. Listen for the “click” and check that both connectors are securely attached to the lower anchorages by pulling on the Car Seat.

**IMPORTANT:** Always make sure the LATCH Connectors are securely connected to the vehicle lower anchorages. (Fig 35-3)

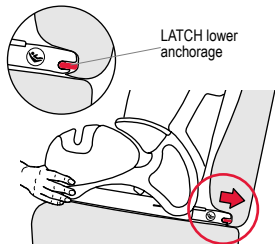

35-3

3. The FastBack has (3) recline positions when used as a toddler car seat. Adjust the seat recline to the desired position for your child. To adjust the recline angle pull the Recline Handle and adjust the Recline Foot up or down. (Fig 36-1)

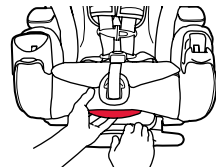

36-1

4. Press the Yellow Release Tabs on both sides (Fig 36-2), grasp the lower part of the Car Seat, and slide the car seat and pushing it firmly against the vehicle seat as shown. (Fig 36-3)

Note: The LATCH Connectors will automatically lock into place as they retract into the car seat.



36-2

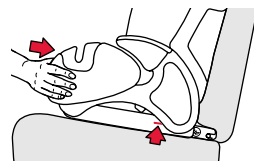

36-3

## Attach the Tether Strap

Vehicle seating positions equipped with LATCH will have top tether anchors in most vehicles. Use Tether Strap whenever possible.

1. Fasten the Tether Hook to the vehicle tether anchor point. (Fig 36-4)

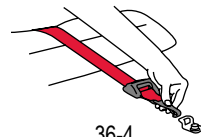

36-4

2. Tighten the Tether Strap securely by pulling the free end of the Tether Strap firmly toward you as shown. (Fig 37-1)

Note: To loosen/lengthen the Tether Strap, press on the Tether Adjuster button while pulling on the Tether Hook.

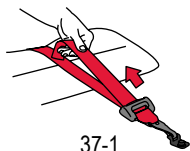

37-1

### Remove Car Seat

- Disconnect Tether Strap.
- Store the Tether Hook and Tether Strap when not in use.

#### To store the Tether Strap:

1. Lengthen the strap and slide the Tether Hook onto the lower edge of the booster seat as shown. (Fig. 37-2)
2. Tighten the strap so Tether Hook is securely held in place. (Fig. 37-3)

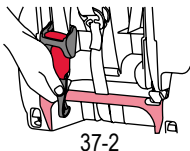

37-2

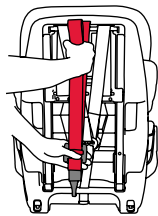

37-3

- Disconnect LATCH Lower Connectors

#### To disconnect the LATCH Connectors:

1. To detach the LATCH Connectors, press the LATCH Extend Buttons (Fig 37-4) and pull the car seat away from the vehicle seat to extend the LATCH Connectors.

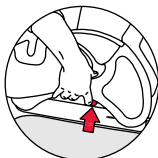

37-4

2. Press the LATCH Release Button on each LATCH Connector (Fig 38-1) and pull away from the vehicle anchors. Store the LATCH Connectors when not in use by pressing the Yellow Release Tabs and pushing the LATCH connector back into the car seat.

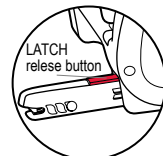

38-1

### 10.2 Installation with Vehicle Belt

## **! WARNING!**

**DEATH or SERIOUS INJURY can occur:**

**FAILURE TO PROPERLY SECURE YOUR CHILD IN THE CHILD RESTRAINT INCREASES THE RISK OF SERIOUS INJURY OR DEATH IN THE EVENT OF A SHARP TURN, SUDDEN STOP OR CRASH.**

## **! WARNING**

**VEHICLE LAP BELT MUST STAY TIGHTLY ADJUSTED TO CHILD RESTRAINT AT ALL TIMES. IF VEHICLE BELT DOES NOT STAY TIGHT, READ VEHICLE OWNER'S MANUAL AND "VEHICLE SEAT BELT REQUIREMENTS" SECTION IN THIS MANUAL**

**IMPORTANT:** The Car Seat **MUST NOT** hang over the edge of the vehicle seat. (Fig 38-2)



38-2

## 10.2.1 WITH Vehicle Lap/Shoulder Belt

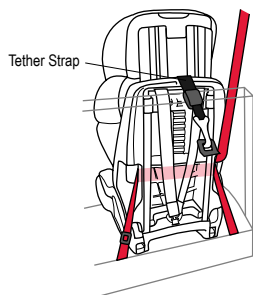

39-1

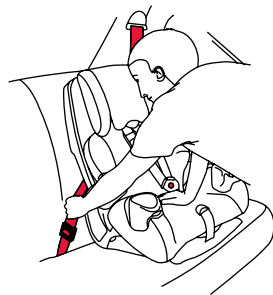

39-2

## 10.2.2 WITH Vehicle Lap Belt only

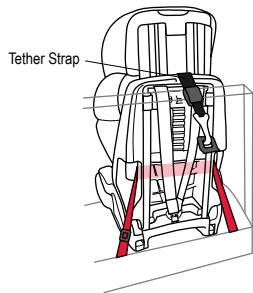

39-3

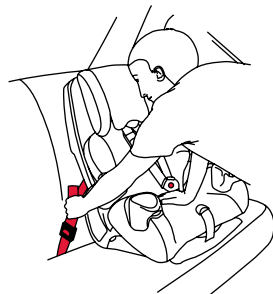

39-4

## 10.2.3 WITH Vehicle Lap Belt only, NO Tether Strap, and children under 30 lbs

Check to see if all three of the following conditions are true:

- Your child weighs less than 30 lbs (13.6 kg)
- The vehicle seat position is not equipped with tether anchor
- The vehicle seat position is equipped with only a lap belt

If these three statements are true, then the vehicle belt must be installed using this method.

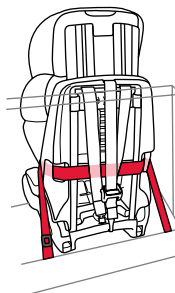

40-1

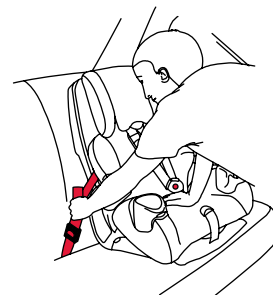

40-2

1. If vehicle seat back is adjustable, adjust into the upright position or the position or the position specified in the vehicle owner's manual for use with a Car Seat.

2. The FastBack has (3) recline positions when used as a toddler car seat. Adjust the seat recline to the desired position for your child. To adjust the recline angle pull the Recline Handle and adjust the Recline Foot up or down. (Fig 41-1)

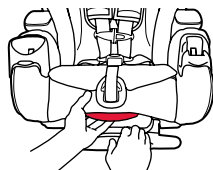

41-1

3. Place the Car Seat firmly against the back of a forward-facing vehicle seat.

4. Thread the vehicle seat belt through the belt slot openings as shown. (Vehicle Lap/Shoulder Belt: Fig 39-1) (Vehicle Lap Belt only: Fig 39-3) (Vehicle Lap Belt only, no Tether Strap and for children under 30 lbs: Fig 40-1)

5. Buckle the vehicle seat belt. Note: The belt **MUST NOT** be twisted.

6. Tighten the vehicle seat belt by pushing down hard with your hand or knee in the middle of the Car Seat. Then pull the vehicle seat belt to tighten. (Vehicle Lap/Shoulder Belt: Fig 39-2) (Vehicle Lap Belt only: Fig 39-4) (Vehicle Lap Belt only, no Tether Strap and for children under 30 lbs: Fig 40-2) Note: For more information on how to tighten

the belt for your vehicle seat belt system, see **Section 8.0 Selecting the Best Vehicle Seat Location** and **Section 9.1 SAFE Seat Belt Systems**, or your vehicle owner's manual.

7. Attach the Tether Strap and tighten.

- Fasten the Tether Hook to the vehicle tether anchor point. (Fig 42-1)

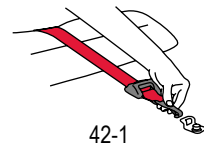

42-1

- Tighten the Tether Strap securely by pulling the free end of the Tether Strap firmly toward you as shown. (Fig 42-2)

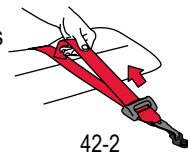

42-2

Note: To loosen/lengthen the Tether Strap, press on the Tether Adjuster button while pulling on the Tether Hook.

8. If the vehicle seat position is not equipped with tether anchor, store the Tether Hook and Tether Strap.

- Lengthen the strap and slide the Tether Hook onto the lower edge of the booster seat as shown. (Fig. 42-3)

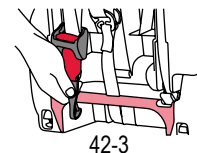

42-3

- Tighten the Tether Strap so Tether Hook is securely held in place. (Fig. 43-1)

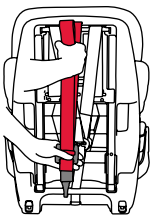

43-1

9. **CHECK TO MAKE SURE CAR SEAT IS TIGHTLY SECURED** by twisting and pulling the Car Seat forward and to both sides to make sure the vehicle seat belt does **NOT** loosen and that the Car Seat does **NOT** easily move.

**IMPORTANT:** The Car Seat should not move more than one 1" (2.5 cm) side-to-side or back and forth. If Car Seat moves more than 1" or the vehicle seat belt does not stay tightly secured, repeat the installation procedure or find another seat location for the Car Seat. (See Section 8.0 Selecting the Best Vehicle Seat Location) Refer to vehicle seat belt section for vehicle belt types and if a Locking Clip is required.

## 11.1 Securing Your Child with Build-in Safety Harness

### **⚠ WARNING!**

**DEATH or SERIOUS INJURY** can occur:

**PROPER INSTALLATION AND USE IS REQUIRED! FAILURE TO PROPERLY SECURE YOUR CHILD IN THE CHILD RESTRAINT INCREASES THE RISK OF SERIOUS INJURY OR DEATH IN THE EVENT OF A SHARP TURN, SUDDEN STOP OR CRASH.**

- Failure to properly adjust the harness on your child increases the risk of death or serious injury in the event of a sudden stop or crash. Follow the instructions very closely to ensure that the harness is properly adjusted to fit your child at all times. Your child will grow very rapidly! Please check the fit of the harness every time you use the Car Seat.
- Snugly adjust harness provided with the Car Seat around child.
- For snug harness fit, use Body Insert for small child.
- Harness strap covers must always be used when using the harness system.
- Discontinue use of harness when child's weight exceeds 70 lbs (31.7 kg) or shoulders are above top harness strap slots.
- Do not use accessories such as strap covers, blankets, cushions, or padding under harness straps or child unless provided by Baby Trend.

- **Do not use Car Seat with harness straps loose or unbuckled. Harness straps MUST be snug and positioned over shoulders and thighs of child.**

In a crash, the Car Seat provides NO protection for your child unless the harness straps are properly secured and installed according to these instructions. Make sure that the harness straps are properly adjusted and secured whenever using the Car Seat.

**IMPORTANT:** Adjust the harness snugly every time you place your child in the Car Seat and **AVOID** bulky clothing.

We recommend using the built-in safety harness for as long as possible before changing to the high back booster mode.

Both the harness height and crotch belt length are adjustable. Always properly adjust to fit your child as indicated in this section.

1. Loosen built-in safety harness by pressing the Harness Adjuster Button and pulling the harness assembly toward you. (Fig 45-1)

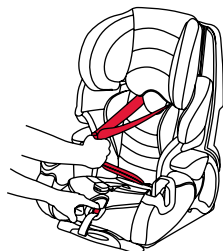

45-1

2. Open Harness Clip by pressing button and sliding apart. (Fig 46-1)

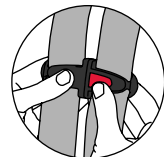

46-1

3. Unbuckle Harness Buckle by pressing button. (Fig 46-2)

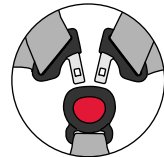

46-2

4. Place child in seat with child's back contacting Back Support and rump contacting seating surface.
5. Check that harness slots are at or above the child's shoulders. Adjust the seat back if necessary. (Fig 46-3)



46-3

6. Place Built-in Safety Harness over child's shoulders and insert both buckle tongues into the Harness Buckle until they click into place.

Note: Make sure that **BOTH** tongues click into place. (Fig 46-4)

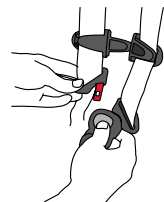

46-4

7. Check buckle height. If buckle is too low or too high, adjust height. (see **Section 11.2 Adjusting Crotch Strap Length**)
8. Check that the straps are not twisted and lie flat over the shoulders. Check that the harness is secure by pulling up and forward on the straps.
9. Connect the Harness Clip and position the Harness Clip at the middle of the child's chest, level with the armpits. (Fig 47-1)
10. The Crotch Strap should be adjusted so that a gap of 1/2" to 1" is present between the ears of the buckle and the top of child's thigh (Fig 47-2), disregarding any clothing or diaper.
11. Tighten the harness straps to snugly adjust harness around child by pulling the Harness Adjuster Strap at the front of the Car Seat as shown. (Fig 47-3)
12. Make sure the straps are flat and snug against the child's shoulders and thighs. **NOTE:** A snug strap should not allow any slack. It lies in a relatively straight line

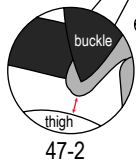
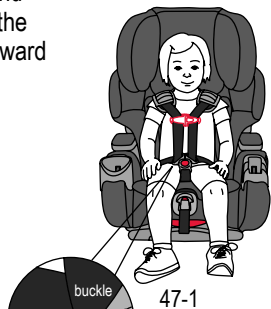

without sagging. It does not press on the child's flesh or push the child's body into an unnatural position.

### Removing Your Child from Built-in Safety Harness

1. Open Harness Clip by pressing button and sliding apart.
2. Unbuckle the Harness Buckle by pressing the red button.
3. Press the Harness Adjuster Button and pull outward on the straps to loosen.
4. Slide the harness straps off the child's shoulders and arms.
5. Remove your child.

### 11.2 Adjusting the Crotch Strap Length

1. Remove either the Cup Holder or the Game Holder to free the Seat Pad from the seat shell. The Cup/Game Holders are removed by pressing in the retainer button and pulling up on the holder. (Fig 48-1)
2. Pull back the Seat Pad from the seat shell to reveal the Crotch Strap cavity.
3. You will see the Crotch Strap anchor clip riding in a slot in the Crotch Strap

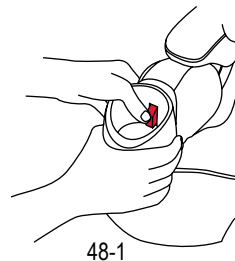

cavity in the seat shell. Pull outward on the metal clip while feeding the Crotch Strap webbing downward until the Crotch Strap metal clip is removed from the slot. (Fig 49-1) **DO NOT** attempt to completely remove the Crotch Strap from the Car Seat.

- Adjust the length of the Crotch Strap to the desired length. For small children, the length of the Crotch Strap is shortened by wrapping additional strap material around the metal clip. For larger children, the length is increased by unwrapping material from around the metal clip. (Fig 49-2)

- Reinsert the Crotch Strap metal clip into the slot in the Crotch Strap cavity while pulling upward on the Crotch Strap buckle. Check that the Crotch Strap metal clip is completely seated all the way down in the slots before using the Car Seat. (Fig 49-3)

- Push the Crotch Strap buckle back up through the slot in the Seat Pad and return the Seat Pad to its original position on the seat shell.

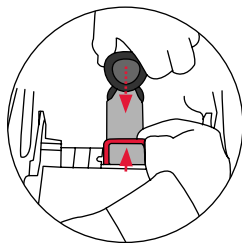

49-1



49-2



49-3

Replace the Cup/Game Holder by pushing it down into its slot until the retainer button clicks and locks it into place.

### 11.3 Adjusting Flex-Sides™ Back Support

**When using WITH the Built-in Safety Harness** this Car Seat features an adjustable Flex-Sides™ Back Support system. Adjusting the seat back adjusts the Built-in Safety Harness to properly fit as your child grows. **NO harness re-threading is required.**

**To adjust the height of the seat back and harness straps:**

- Lift the fabric cover to reveal the Height Adjustment Button. (Fig 50-1)

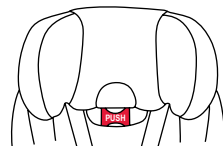

50-1

- Firmly press in the Height Adjustment Button and slide the seat back up or down to adjust to the desired height. (Fig 50-2)

Note: The adjustable back has eight (8) height positions. Check to make sure the seat locks into one of the eight positions before use.

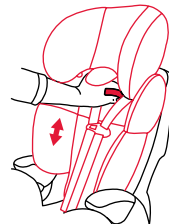

50-2

**! WARNING!**

DEATH or SERIOUS INJURY can occur:

FAILURE TO PROPERLY SECURE YOUR CHILD IN THE BOOSTER SEAT INCREASES THE RISK OF SERIOUS INJURY OR DEATH IN THE EVENT OF A SHARP TURN, SUDDEN STOP OR CRASH.

- Proper installation is required.
- We recommend using the built-in safety harness for as long as possible before changing to the high back booster mode.
- Child must be at least 3 years old and weigh at least 30 lbs (13.6 kg) to use the booster mode.
- Use only the vehicle lap/shoulder belt system when restraining the child in this booster seat.
- Never use the booster seat with only a vehicle lap belt across the front of the child. Using a booster seat with only a lap belt could result in serious injury or death.
- Snugly adjust the lap/shoulder belt around child according to the instructions in the vehicle's owner's manual.
  - Shoulder belt must be properly positioned over shoulder (NOT touching child's neck and NOT off shoulder).
  - Vehicle lap belt must be positioned low on the hips, contacting the thighs.
  - Never use shoulder belt loose, positioned under child's arm, or behind child.
- If child will not keep vehicle shoulder belt properly positioned

on shoulder, DO NOT use this booster seat. Use a different child restraint system.

- Do not allow child to slide down in booster seat which could position vehicle lap belt across child's abdomen and should belt over neck and face.
- Do not use Body Insert in booster seat mode.
- Shoulder belt must slide freely in the inner slot of booster shoulder belt guide in head support.
- The booster seat MUST NOT hang over the front edge of the vehicle seat. (Fig 52-1)
- Vehicle seat headrest MUST NOT create a gap between the vehicle seat and the booster seat. (Fig 52-2)



52-1



52-2

## 12.1 Preparation for Installation

**! WARNING**

SECURELY BELT THIS CAR SEAT IN VEHICLE, EVEN WHEN NOT OCCUPIED. AN UNSECURED CAR SEAT CAN INJURE OTHER OCCUPANTS IN A CRASH.

The booster seat may be secured to the vehicle using the LATCH system or top tether only. Securing the booster holds the seat in position when a child is getting in or out of the booster and during a crash.

## 12.1.1 Remove Built-in Safety Harness

1. Release Harness Buckle and open chest clip. (Fig 53-1)

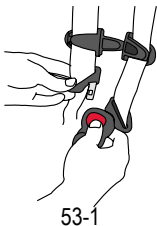

2. On back of Car Seat, disconnect shoulder straps from Harness Connector Plates. (Fig 53-2)

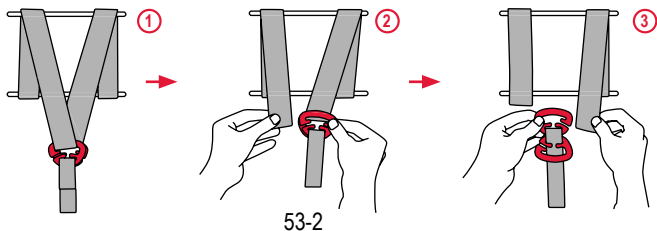

3. Pull the harness straps through the front of the seat. (Fig. 53-3)

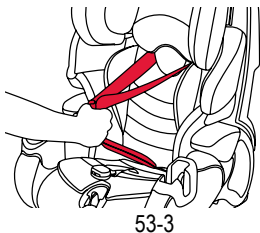

4. Facing the Car Seat, lift the Fold Lock Levers and pull the back of the Car Seat gently forward. (Fig 54-1)

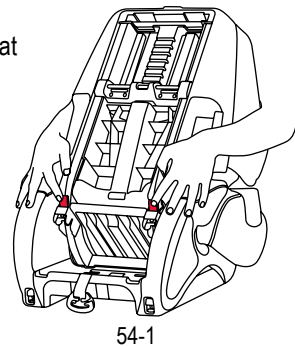

5. Slip harness out from under tabs (Fig 54-2) and pull the harness strap out of the seat. Return the seat back to its locked position.

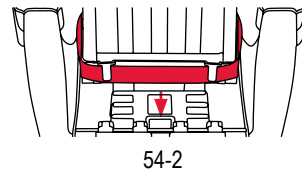

### 12.1.2 Built-in Safety Harness Storage

- Store safety harness in a safe place where it is not exposed to the elements or water. **NEVER** use a damaged safety harness. Always check for damage before use. (See Section 13.0 Care and Maintenance)
- Store the Crotch Buckle by pushing it through the slot and tucking it away in the empty space under the Seat Pad. Store the Harness Adjuster Strap and the Harness Connector Plates by tucking them away in the same space. (Fig. 55-1)

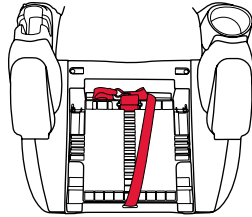

55-1

### 12.1.3 Reinstalling the Built-in Safety Harness

1. Facing the Car Seat, lift the Fold Lock Levers and pull the back of the Car Seat gently forward. (Fig 55-2)

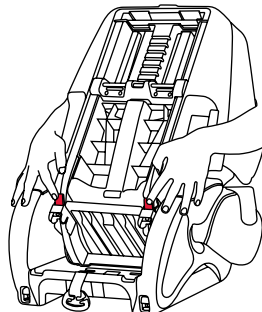

55-2

2. Center the harness and slip it underneath the tabs on the inside of the seat. Wrap the loose ends of the harness strap around to the front of the seat and pull firmly to eliminate slack. Unfold the seat back until it locks into place. (Fig 56-1)

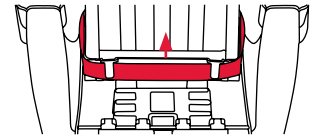

56-1

3. Insert the buckle tongues into the Crotch Buckle. Thread the harness through the slots on the buckle tongues and the chest clip as shown. (Fig 56-2)

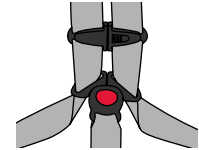

56-2

4. Lift the fabric flap and thread the ends of the harness straps through the harness slots. (Fig 56-3)

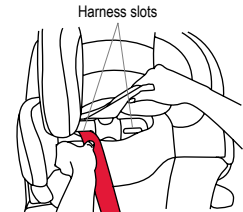

56-3

5. Pull the strap ends through the back of the seat and thread the straps up and over the upper cross-bar as shown. The straps **MUST** be threaded over the cross-bar to function correctly. (Fig 57-1) **DO NOT** use the Car Seat if the harness strap is not properly installed.

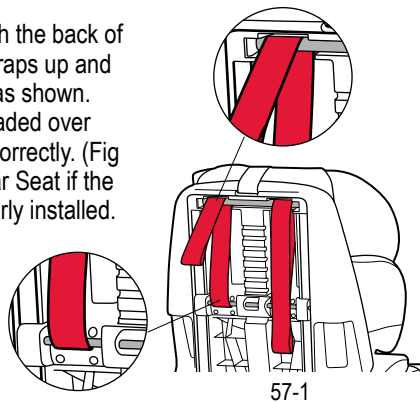

6. Hook the looped ends of the harness strap to the Harness Connector Plates. (Fig 57-2) Ensure that the straps are securely connected to the connector plates. **DO NOT** use the Car Seat if the harness strap is not properly installed.

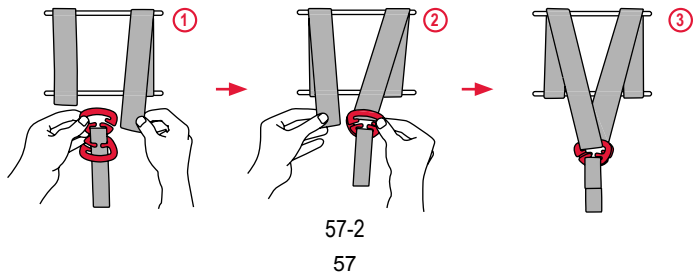

## 12.2 Installation with LATCH System

If a LATCH attachment system is not available or will not be used, go to next section.

1. Adjust Recline Foot into the fully extended position. Pull out on the Recline Handle while pressing down on the Recline Foot and lift up on the front of the Car Seat. (Fig 58-1)

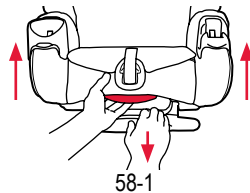

2. If vehicle seat back is adjustable, adjust into the upright position or the position specified in the vehicle owner's manual for use with a Car Seat.

3. Extend LATCH Connectors by pressing the LATCH Extend Button on each side as shown. (Fig 58-2)

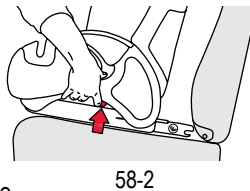

4. Place the booster seat in a forward-facing, LATCH equipped vehicle seat.
5. Attach the LATCH Connectors to the vehicle LATCH lower anchorages, pull to check that LATCH Connectors are securely attached. (See section 10.1)
6. Attach the Tether Strap and tighten. (See section 10.1)

### 12.3 Installation with Vehicle Lap/Shoulder Belt

## ⚠ WARNING!

DEATH or SERIOUS INJURY can occur:

NEVER USE ONLY A VEHICLE LAP BELT ACROSS THE FRONT OF YOUR CHILD. (Fig 59-1)



59-1

DO NOT PLACE SHOULDER BELT BEHIND YOUR CHILD'S BACK. (Fig 59-2)



59-2

DO NOT POSITION SHOULDER BELT UNDER CHILD'S ARM OR USE LOOSE. (Fig 59-3)



59-3

DO NOT PLACE VEHICLE LAP BELT OVER TOP OF ARMRESTS, CUP/GAME HOLDER. (Fig 59-4)



59-4

1. If vehicle seat back is adjustable, adjust into the upright position or the position or the position specified in the vehicle owner's manual for use with a Car Seat.
2. Place booster seat firmly against the back of a forward-facing vehicle seat equipped with a lap/shoulder belt only.
3. If available, attach the Tether Strap and tighten.
  - Fasten the Tether Hook to the vehicle tether anchor point. (Fig 60-1)

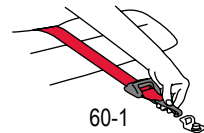

60-1

- Tighten the Tether Strap securely by pulling the free end of the Tether Strap firmly toward you as shown. (Fig 60-2)
- Note: To loosen/lengthen the Tether Strap, press on the Tether Adjuster button while pulling on the Tether Hook.

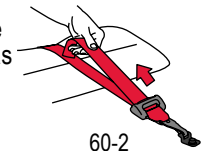

60-2

4. Position the vehicle shoulder belt through the shoulder belt guide. (Fig 60-3) **DO NOT** place underneath the shoulder belt guide. (Fig 60-4)

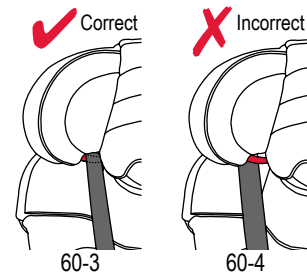

60-3

60-4

## 12.4 Securing Child in High-Back Booster Seat

1. Place child in High-Back booster seat with child's back and rump contacting seating surfaces.
2. Slide vehicle lap belt into slot below Armrest and into vehicle belt guide, the vehicle lap belt should pass through the Vehicle Lap Belt Guide indicated by the **RED** colored section below the Armrest.
3. Fasten the vehicle belt buckle and pull up on the shoulder belt to tighten. (Fig 61-1)



61-1

4. Check to make sure that the shoulder belt is positioned properly over the shoulder and is snug against the child. The lap portion of the lap/shoulder belt **MUST** be low and snug on your child's hips, just touching the thighs. (Fig 61-2) A snug strap should not allow any slack. It lies in a relatively straight line without sagging. It does not press on the child's flesh or push the child's body into an unnatural position.

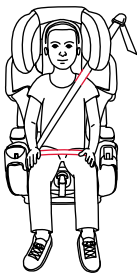

61-2

## 12.5 Adjusting Flex-Sides™ Back Support and Head Support

Both Flex-Sides™ Back Support and Head Support are adjustable. Always properly adjust to fit your child as indicated in this section.

1. Lift the fabric cover to reveal the Height Adjustment Button for both Flex-Sides™ Back Support and Head Support. (Fig 62-1)

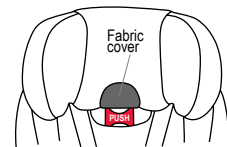

62-1

2. Firmly press in the Height Adjustment Button and slide the Flex-Sides™ Back Support up or down to center shoulder belt on child's shoulder. (Fig 62-2) If the belt lies across the child's neck, head or face, adjust the belt to pass over the child's shoulder by adjusting the height of the Flex-Sides™ Back Support.

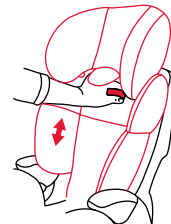

62-2

Note: The adjustable back has eight (8) height positions. Check to make sure the seat locks into one of the eight positions before use.

3. If the Flex-Sides™ Back Support is already in the highest height position, then adjust the height of the head support so that the Vehicle Shoulder Belt Guide is in the proper position for your child. (Fig 63-1) Only adjust the head support when Flex-Sides™ Back Support are in the highest height position.

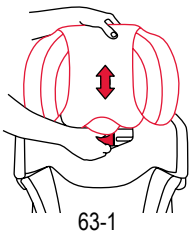

4. Reach up beneath the seat fabric and pull the fabric flap away from the velcro that holds it in place. (Fig. 63-2)

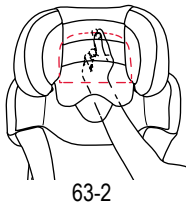

5. Pull the fabric flap down into position. (Fig. 63-3)

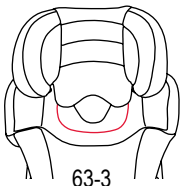

6. If the fabric flap is no longer needed, simply fold the flap back up into the head rest fabric and secure it using the attached velcro.

### **⚠ WARNING!**

**DEATH or SERIOUS INJURY** can occur:

**FAILURE TO PROPERLY SECURE YOUR CHILD IN THE CHILD RESTRAINT INCREASES THE RISK OF SERIOUS INJURY OR DEATH IN THE EVENT OF A SHARP TURN, SUDDEN STOP OR CRASH.**

- Proper installation is required.
- We recommend using the High-Back Booster mode for as long as possible. The Back Support and Head Support provide incremental crash protection in frontal and side impact crashes. Removing the Back Support and Head Support earlier than necessary also removes the incremental crash protection.
- Child must be at least 4 years old and weigh at least 40 lbs (18.1 kg) to use the Backless Booster mode.
- Use only the vehicle lap/shoulder belt system when restraining the child in this booster seat.
- Never use the booster seat with only a vehicle lap belt across the front of the child. Using a booster seat with only a lap belt could result in serious injury or death.
- Snugly adjust the lap/shoulder belt around child according to the instructions in the vehicle's owner's manual.
- Shoulder belt must be properly positioned over shoulder (NOT touching child's neck and NOT off shoulder).

- Vehicle lap belt must be positioned low on the hips, contacting the thighs.
- Never use shoulder belt loose, positioned under child's arm, or behind child.
- Vehicle lap/shoulder belt must be properly positioned on child. Use vehicle shoulder belt positioner to center vehicle shoulder belt on child's shoulders.
- Discontinue use of Backless Booster when top of child's ears are above to edge of vehicle head rest and vehicle seat back.
- If child will not keep vehicle shoulder belt properly positioned on shoulder, DO NOT use this booster seat. Use a different child restraint system.
- Do not allow child to slide down in booster seat which could position vehicle lap belt across child's abdomen and should belt over neck and face.
- The booster seat **MUST NOT** hang over the front edge of the vehicle seat. (Fig 65-1)



65-1

## 13.1 Preparation for Installation

### **! WARNING**

**SECURELY BELT THIS CAR SEAT IN VEHICLE, EVEN WHEN NOT OCCUPIED. AN UNSECURED CAR SEAT CAN INJURE OTHER OCCUPANTS IN A CRASH.**

The booster seat may be secured to the vehicle using the LATCH system. Securing the booster holds the seat in position when a child is getting in or out of the booster and during a crash.

## 13.2 Remove Flex-Sides™ Back Support and Head Support

1. Detach the Seat Pad from the seat back by unhooking the two fabric loops from the tabs on the back of the seat back. (Fig 66-1)
2. Facing the Car Seat, lift the Fold Lock Levers and pull the back of the Car Seat gently forward as shown. (Fig 66-2)  
Note: If harness straps are connected, remove by slipping harness straps out from under tabs. (See Section 12.1.1 **Remove built-in safety harness**)

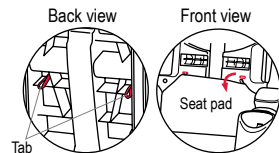

66-1

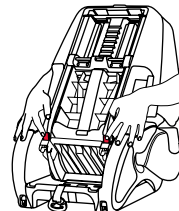

66-2

3. Release the "U-bar" one side at a time by pressing the spring release buttons and lifting up slightly on the corresponding side of the assembly. (Fig 67-1)

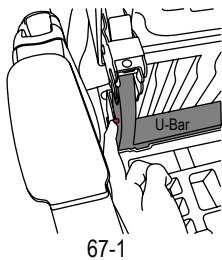

4. Grasping both sides of the Back Support, lift up and detach it from the hatch. (Fig 67-2)

**NOTE:** When the Back Support is removed, the instruction manual must be stored in the storage pocket on the underside of the Seat Pad. (Fig 67-2)

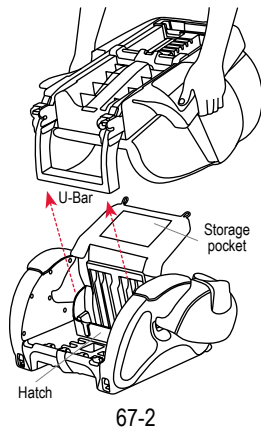

4. Store the Crotch Buckle by pushing it through the slot and tucking it away in the empty space under the Seat Pad. Store the Harness Adjuster Strap and the Harness Connector Plates by tucking them away in the same space. (Fig. 68-1)

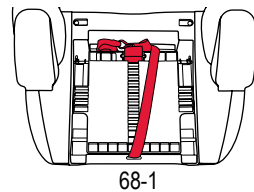

5. Push the Seat Pad down into place and secure using the two elastic loops. (Fig 68-2)

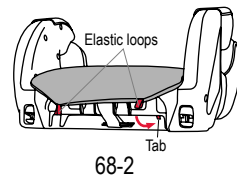

### 13.3 Reinstalling Flex-Sides™ Back Support and Head Support

1. Unhook the back of the Seat Pad and lift up to open hatch.

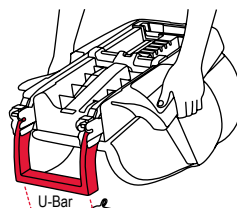

2. With the hatch open, lower the Back Support and insert U-bar into hatch as shown. (Fig 68-3) Ensure that U-bar is properly aligned with hatch.

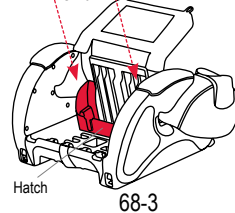

3. As the U-bar slides into the hatch, press the two spring release buttons (located on each side of the U-bar) while pushing the U-bar down to allow the U-bar to snap securely into place. (Fig 69-1) The Back Support **MUST** be securely installed before using the Car Seat/Booster seat.

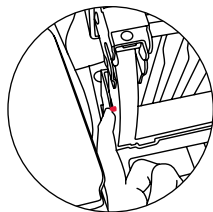

69-1

4. Reattach the Seat Pad to the seat back by pulling the fabric loops on the back of the Seat Pad through the small holes in the seat back and hooking them on the tabs. (Fig 69-2)

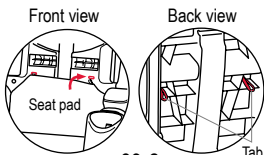

69-2

5. Push the Back Support backward until it clicks into its locked position. (Fig 69-3) Pull to make sure the Back Support is securely locked into place.

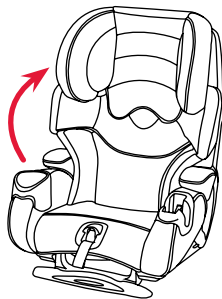

69-3

**NOTE:** If using in Toddler Car Seat mode with the built-in safety harness, refer to **Section 12.1.3 Reinstalling the Built-in Safety Harness.**

### 13.4 Installation with LATCH System

If a LATCH attachment system is not available or will not be used, go to next section.

1. Adjust Recline Foot into the fully extended position. Pull out on the Recline Handle while pressing down on the Recline Foot and lift up on the front of the Car Seat. (Fig 70-1)

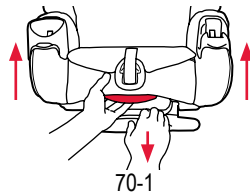

70-1

2. If vehicle seat back is adjustable, adjust into the upright position or the position or the position specified in the vehicle owner's manual for use with a Car Seat.

3. Extend LATCH Connectors by pressing the LATCH Extend Button on each side as shown. (Fig 70-2)

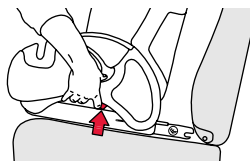

70-2

4. Place the booster seat in a forward-facing, LATCH equipped vehicle seat.

5. Attach the LATCH Connectors to the vehicle LATCH lower anchorages, pull to check that LATCH Connectors are securely attached. (See section 10.1)

## 13.5 Installation with Vehicle Lap/Shoulder Belt

**WARNING!**

DEATH or SERIOUS INJURY can occur:

NEVER USE ONLY A VEHICLE LAP BELT ACROSS THE FRONT OF YOUR CHILD. (Fig 71-1)



71-1

DO NOT PLACE SHOULDER BELT BEHIND YOUR CHILD'S BACK. (Fig 71-2)



71-2

DO NOT POSITION SHOULDER BELT UNDER CHILD'S ARM OR USE LOOSE. (Fig 71-3)



71-3

DO NOT PLACE VEHICLE LAP BELT OVER TOP OF ARMRESTS, CUP/GAME HOLDER. (Fig 71-4)



71-4

1. Place the booster seat firmly against the back of a forward-facing vehicle seat.
2. Position vehicle lap belt into Vehicle Lap Belt Guide by sliding lap belt through slot under Armrest.
3. Place child in booster seat with child's back flat against the vehicle seat.
4. Pull vehicle lap/shoulder belt across front of child and buckle vehicle seat belt. (Fig 72-1)
  - The belt should pass through the Vehicle Lap Belt Guide indicated by the **RED** colored section below the Armrest.
  - Vehicle shoulder belt on buckle side must be under Armrest.
5. Position the lap belt low on the child's hips, the lap portion of the lap/shoulder belt **MUST** be low and snug on the child's hips, contacting the thighs.



72-1

6. Position the lap/shoulder belt so that it lies across the child's shoulders as shown. (Fig 73-1) If the vehicle shoulder belt does not lie across the child's shoulder as shown, the Shoulder Belt Positioning Clip **MUST** be used. See **Section 13.6 Using Shoulder Belt Positioning Clip**.

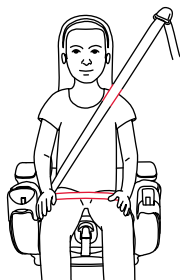

73-1

7. Check fit of the vehicle seat belts on child:

- Vehicle lap belt must be low on hips contacting the thighs.
- Vehicle shoulder belt must contact the chest and be centered on the shoulder. Use the shoulder belt positioner clip to adjust the position of the vehicle shoulder belt.
- **DO NOT** place vehicle shoulder belt under child's arm or behind child.

**IMPORTANT:** The booster seat should not move more than one 1" (2.5 cm) side-to-side or back and forth. If booster seat is not secure, repeat the installation procedure or find another seat location for the booster seat. (See **Section 8.0 Selecting the Best Vehicle Seat Location**)

### 13.6 Using Shoulder Belt Positioning Clip

Use the Shoulder Belt Positioning Clip (Fig 74-1) to center the vehicle shoulder belt on the child's shoulder. Shoulder belt **MUST** be centered on child's shoulder as shown. (Fig 74-2)

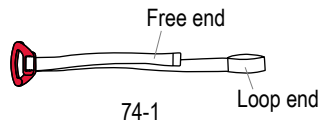

74-1

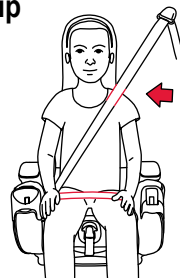

74-2

Attaching the Shoulder Belt Positioning Clip to backless booster:

1. Unhook elastic loops at the back of the Seat Pad and lift the Seat Pad up. Set aside the Harness Adjuster Strap and lift open the hatch. (Fig 74-3)
2. Lay Shoulder Positioning Belt Clip out on flat surface with free end on top.
3. Thread the loop end of the strap through the slot on the rear of the booster seat. (Fig 74-4)

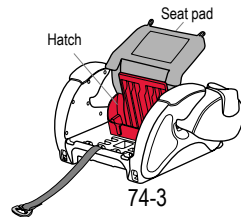

74-3

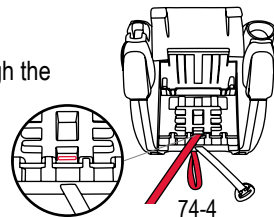

74-4

## 13.0 Securing Backless Booster Seat in Vehicle

4. Thread the clips and free end of the strap through the loop end and pull to eliminate slack. (Fig 75-1)

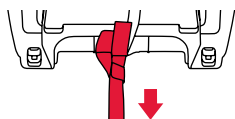

75-1

5. Close the seat compartment and store the Crotch Buckle and Harness Adjuster Strap in their storage area. (Fig 75-2)

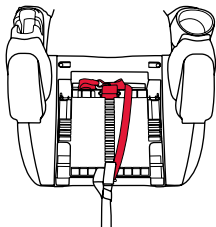

75-2

6. Lower the Seat Pad down and reattach using the two elastic loops. Note: The clip should be positioned so that the free end of the strap faces toward the front seat. (Fig 75-3)

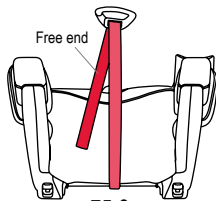

75-3

## 13.0 Securing Backless Booster Seat in Vehicle

7. Separate the two halves of the Shoulder Belt Positioning Clip (Fig 76-1) and insert the vehicle shoulder belt into both sides of the clip. (Fig 76-2)



76-1

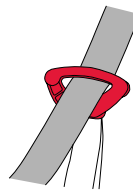

76-2

8. Pull the free end of the strap down to tighten the clip against the child's shoulder and bring the shoulder belt into the proper position. (Fig 76-3)

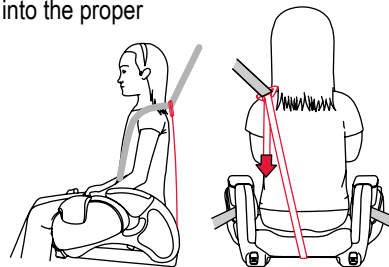

Side View

76-3

Rear View

9. The lap portion of the lap/shoulder belt **MUST** be low and snug on your child's hips, just touching the thighs.

**DO NOT** allow your child to slide down in the booster seat. (Fig 76-4)



76-4

## 14.0 OPTIONAL ACCESSORIES (on certain models ONLY)

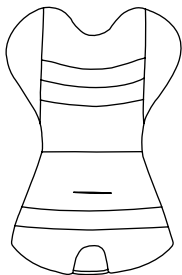

BODY INSERT

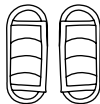

HARNESS COVERS

### **⚠ WARNING!**

**DEATH or SERIOUS INJURY can occur:**

**IMPROPER USE OF THE OPTIONAL ACCESSORIES CAN CAUSE THE CHILD RESTRAINT TO NOT PERFORM AS DESIGNED RESULTING IN SERIOUS INJURY OR DEATH IN A SUDDEN STOP, SHARP TURN OR CRASH.**

**NEVER** allow the Body Insert to bunch or fold behind your child. Discontinue use as your child grows.

Make sure that the Harness Covers **DO NOT** interfere with the correct placement of the chest clip at armpit level. If Harness Covers do interfere, remove them from the harness straps and **DO NOT** use until your child grows and they no longer interfere.

## 14.1 Body Insert

### To remove Body Insert:

1. Open Harness Clip by pressing button and sliding apart.
2. Unbuckle the Harness Buckle by pressing the red button.
3. Unhook the elastic loop from underneath the Harness Adjuster Button housing. (Fig 78-1)
4. Push the Harness Buckle down through the slot in the Body Insert.
5. Remove Body Insert.

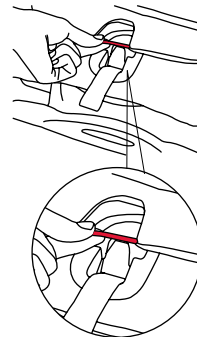

78-1

### To install Body Insert:

1. Place the Body Insert on the car seat.
2. Pull the Harness Buckle up through the slot in the Body Insert.
3. Hook the elastic loop underneath the Harness Adjuster Button housing. (Fig 78-2)

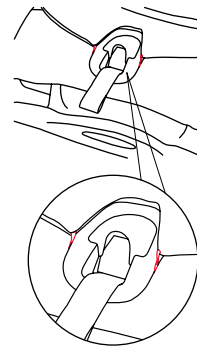

78-2

## 15.0 CARE & MAINTENANCE

### Vehicle seat:

Use a child restraint mat, towel or other cloth to protect vehicle seat upholstery. Continuous use of a child restraint may cause damage to an unprotected vehicle seat.

### Car Seat – Plastic and Metal components:

Clean with mild soap and cold water. **DO NOT** use bleach or harsh detergents.

### Seat pad, Back Support Pad, and Head Support Pad:

For care and maintenance, read and follow instructions on fabric tags.

### Built-in Safety Harness and Tether Strap:

Spot clean with damp cloth or replace. **DO NOT** immerse straps in water. The straps may weaken and not perform as designed.

### Buckle and Tether Adjuster:

Wipe clean with damp cloth **ONLY**. If buckle will not securely lock, **DO NOT** use this child restraint.

## 16.0 AIRPLANE USE

This child restraint is certified for use in Aircraft **ONLY** when used with the Built-in Safety Harness. Install the child restraint in the same manner it is install in a motor vehicle using the aircraft lap belt. Make sure that the aircraft lap belt holds the child restraint securely at all times.

**IMPORTANT:** When used as a booster seat **WITHOUT** the Built-in Safety Harness, this restraint is **NOT CERTIFIED** for aircraft use because aircraft seats do not have a shoulder belt.

