

Read all instructions BEFORE assembly and USE of product.
KEEP INSTRUCTIONS FOR FUTURE USE.

Item#: PY90918

Check that you have all the below parts for this model
before assembling the playard.

Nursery Center

Playard (fully assemble) x 1
Mattress x 1

Travel / Storage Bag x 1

Close N Cozy

Soft Goods x 1
Strap Set x 1
Mattress Support Bar x 2
Lower Bar x 2
Center Cross Bar x 1
Upper Back Bar x 1
Upper frame x 2
Side frame x 2
Leg x 4
Screw x 4

Nursery Center

Mini Playard with Close N Cozy

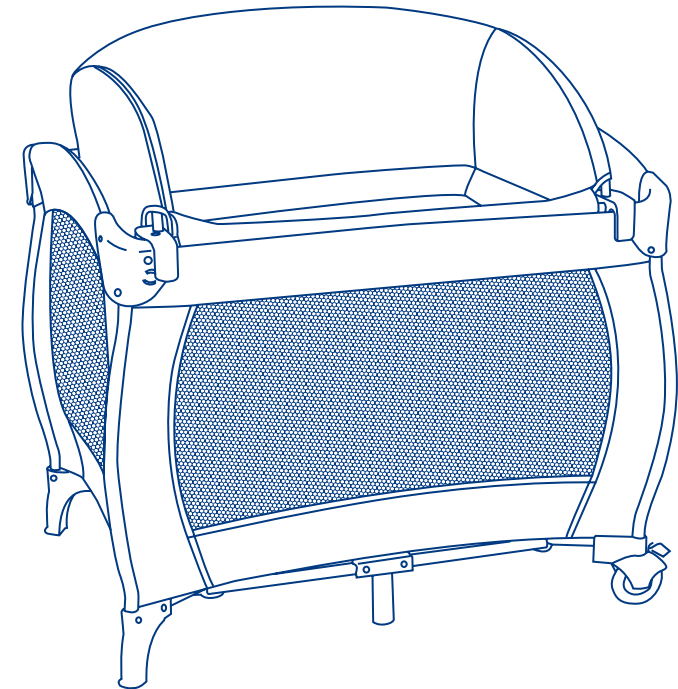

**IF YOU EXPERIENCE ANY DIFFICULTY IN USING THIS PRODUCT,
PLEASE CONTACT OUR CUSTOMER SERVICE DEPARTMENT AT
1-800-328-7363 BETWEEN THE HOURS OF 8:00 A.M. AND 4:30 P.M. PACIFIC
STANDARD TIME FOR ASSISTANCE. PLEASE HAVE YOUR MODEL NUMBER AND
MANUFACTURING DATE AVAILABLE WHEN YOU CALL. THIS INFORMATION CAN BE
FOUND ON A SMALL STICKER UNDER THE PLAYARD.**

baby trend
Convenience through innovation and thoughtful design

Contact us by mail:
Baby Trend, Inc.
1607 S. Campus Ave., Ontario, CA 91761

Contact us by phone:
1-800-328-7363 (8:00am ~ 4:30pm PST)
or online <http://www.babytrend.com>

Instruction Manual

baby trend
Convenience through innovation and thoughtful design
www.babytrend.com

11.09

⚠️ WARNING: NEVER LEAVE INFANT IN PRODUCT WITH SIDES DOWN.

Infant may roll into space between pad and loose mesh side causing suffocation.

⚠️ WARNING:

Infants can suffocate:

- In gaps between a mattress too small or too thick and product sides
 - On soft bedding
- Never add a mattress, pillow, comforter, or padding.
Use only the mattress provided by manufacturer.
Never use a water mattress with this product.

⚠️ WARNING: See playard floor and side rails for warnings.

⚠️ WARNING: Failure to follow these warnings and the instructions could result in serious injury or death.

- **NEVER** use this product if there are any loose or missing fasteners, loose joints, broken parts, or torn mesh/fabric. Check before assembly and periodically during use. Contact Baby Trend Customer Service at 1-800-328-7363 for replacement parts, repair or instructions. **NEVER** substitute parts.
- **NEVER** leave child in product with sides lowered. Be sure sides are in raised and locked position whenever child is in product.
- **NEVER** use plastic shipping bags or other plastic film as mattress covers not sold and intended for that purpose. They can cause suffocation.
- This product is not intended for commercial use.

MAINTENANCE AND CLEANING INSTRUCTIONS:

Use only household mild soap and warm water.

DO NOT USE BLEACH.
DO NOT MACHINE WASH.

-
- The playard, including side rails, must be fully erected prior to use. **Make sure latches are secure.**
 - Strings can cause strangulation! **NEVER** place items with a string around a child's neck such as hood strings or pacifier cords. **NEVER** suspend strings over playard or attach strings to toys.
 - Discontinue use of the product when child is able to climb out or has reached the height of 35 in. (890 mm) or weight of 30 lbs. (14 kgs), whichever comes first.
 - When child is able to pull to standing position, remove bumper pads, large toys and other objects that could serve as steps for climbing out.
 - **NEVER** place product near a window where cords from blinds or draps can strangle a child.
 - Always provide the supervision necessary for the continued safety of your child. When used for playing, **NEVER** leave child unattended.
 - To reduce the risk of SIDS, pediatricians recommend healthy infants be placed on their back to sleep, unless otherwise advised by your physician.

If you experience any difficulty with the use of our product or have a question regarding these instructions, please contact our Customer Service Department at 1-800-328-7363 between the hours of 8:00 a.m. and 4:30 p.m. (PST). Please do not return the product to the store as once it is returned it cannot be re-sold and the materials and energy used to make it are wasted.

Contact us by mail:
Baby Trend, Inc.
1607 S. Campus Ave., Ontario, CA 91761

Contact us by phone:
1-800-328-7363 (8:00am ~ 4:30pm PST)
or online <http://www.babytrend.com>

IMPORTANT! To ensure safe operation of your playard, please follow these instructions carefully. Please keep these instructions for future reference.

IMPORTANT! Before assembly and each use, inspect this product for damaged hardware, loose joints, missing parts or sharp edges. NEVER use if any parts are missing or broken.

IMPORTANT! Adult assembly is required.

PLAYARD

Check the parts list to make sure you have all the parts for this model before assembling the playard.

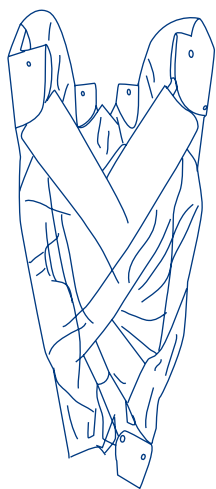

Playard

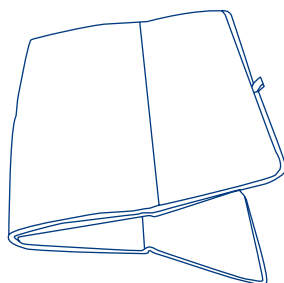

Mattress

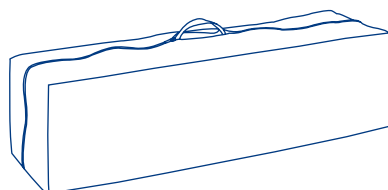

Travel / Storage Bag

TO ASSEMBLE PLAYARD



Playard

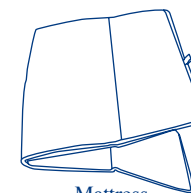

Mattress

ATTENTION:

Playard must be fully assembled and securely locked before installing or using other accessories.

1. Unzip bag and remove Playard frame (Fig. 1). Undo the three (3) Fasten straps and set the Mattress aside.
2. **DO NOT** push center down yet.
3. Top rails must be fully erected before lowering center. Pull up one rail at a time, hold one hand on each side of the rail and pull up sharply, do not pull from the middle where the center latch release is located, make sure both tubes latch in place and each rail is rigid. (Fig. 2).

IMPORTANT: The center must be raised while locking the rails. If one rail will lock but the other side will not then, unlock the rail by squeezing the release in the center and try again.

4. Once all four (4) top rails are locked in place, push down on the center handle (Fig. 3). The center mechanism will rotate clockwise 90 degrees and automatically lock in place.
3. To operate the brakes on the Wheels, press downward on the brake levers. To release, lift upward on the lever (Fig. 4)

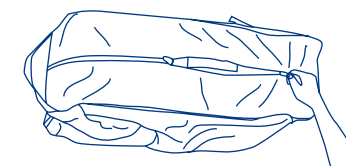

Fig. 1

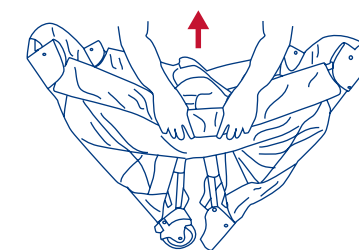

Fig. 2

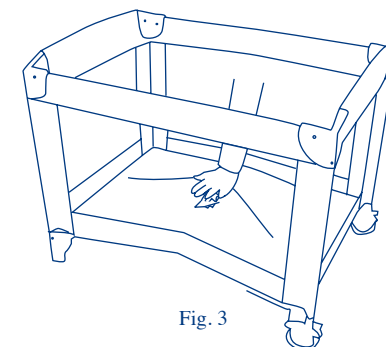

Fig. 3

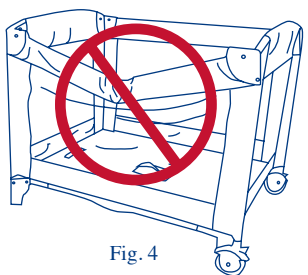

Fig. 4

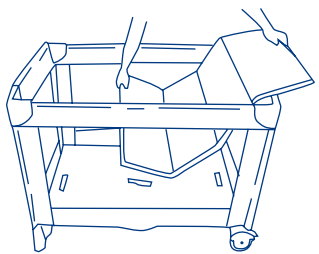

Fig. 5

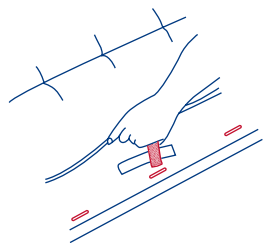

Fig. 6

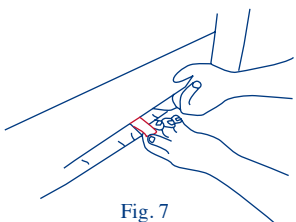

Fig. 7

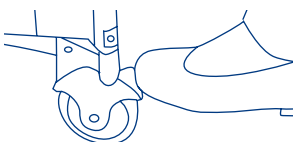

Fig. 8

IMPORTANT: Test each top rail by pushing down slightly to confirm each is rigid and locked securely in place before use. (Fig. 4)

5. Place the Mattress on the floor of the Playard with the padded side facing up. (Fig. 5)

6. Insert the three (3) Velcro® straps located on the underside of the Mattress through the slots in the floor of each end of the Playard (Fig. 6). Fasten the hook and loop straps to the underside of the Playard floor to prevent the Mattress from moving. (Fig. 7)

IMPORTANT: The handle located in the center of the Playard floor **MUST** remain raised (Approx. 45.7 cm or 18 inches) while locking the side rails in place. If the center is not raised the rails will **NOT** lock.

If you experience difficulty and one side of the rail will lock but the other side will not then, unlock the rail by squeezing the release in the center and try again. If you still have difficulty, contact our Customer Service Center at 1-800-328-7363 or visit us online at www.babytrend.com.

7. To operate the brakes on the Wheels, press downward on the brake levers. To release, lift upward on the lever. (Fig. 8)

FOLDING PLAYARD

1. Release the three (3) Velcro® straps holding the Mattress from underneath the Playard floor or the Bassinet and set the mattress aside.

2. Do not unlock top rails yet, center of floor must be raised before top rails will unlock.

3. Rotate the center handle counter-clockwise 90 degrees and raise the center as high as the top rails (Fig. 9). Gather the Legs and Wheels together towards the center as close as possible so that they nearly touch.

4. Locate the rail latch release in the center and bottom side of each rail. Squeeze the lever with two hands until the rail releases the two tubes (Fig. 10), then push down (Fig. 11). **NOTE:** If the top rail(s) do not release completely, **DO NOT FORCE!** Lift the center of floor higher. Both tubes must be released for the top rail to fold.

5. Gather four (4) corners and center all together tightly (Fig. 12). Wrap Mattress around Playard frame with padded side facing inward. Secure the three (3) hook and loop straps by feeding them through the loops on the end of the Mattress and folding them back onto themselves.

6. Wrap Mattress around Playard frame with padded side facing inward.

7. Secure the three (3) hook and loop straps by feeding them through the loops on the end of the Mattress and folding them back onto themselves. (Fig. 13)

8. Place folded Playard into carry bag so that the handle comes through the opening between each side of the zipper.

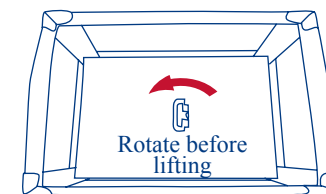
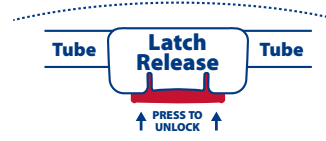

Fig. 9



TOP RAIL

Fig. 10

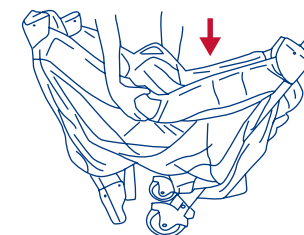

Fig. 11



Fig. 12

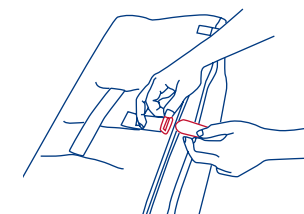

Fig. 13

⚠️ WARNING: Failure to follow these warnings and the instructions could result in serious injury or death.

⚠️ FALL HAZARD: To help prevent falls, do not use this product when the infant begins to push up on hands and knees or has reached the height of 25 in. (635 mm), weight of 15 lbs. (6.8 kgs) or 4 months old, whichever comes first.

⚠️ SUFFOCATION HAZARD: Infants can suffocate

- In gaps between an extra pad and sides of the bassinet/cradle
- On soft bedding

Never add a mattress, pillow, comforter, or padding.

Use only the pad provided by manufacturer.

Never use a water mattress with this product.

- To reduce the risk of SIDS, pediatricians recommend healthy infants be placed on their back to sleep, unless otherwise advised by your physician.
- If a sheet is used with the pad, use only the one provided by the bassinet or cradle manufacturer or one specifically designed to fit the dimension of the bassinet or cradle mattress.
- Strings can cause strangulation! **NEVER** place items with a string around a child's neck such as hood strings or pacifier cords. **NEVER** suspend strings over bassinet or attach strings to toys.
- Discontinue use of the bassinet when child begins to push up on hands and knees or has reached the height of 25 in. (635 mm), weight of 15 lbs. (6.8 kgs) or 4 months old, whichever comes first.
- **NEVER** place product near a window where cords from blinds or drapes can strangle a child.
- Always provide the supervision necessary for the continued safety of your child. **NEVER** leave child unattended.
- **NEVER** use plastic shipping bags or other plastic film as mattress covers not sold and intended for that purpose. They can cause suffocation.
- Use bassinet with only one child at a time.
- **NEVER** place a child under the bassinet.
- **NEVER** store the bassinet in the playard while in use.
- The bassinet must be fully assembled and installed before using.

Contact us by mail:
Baby Trend, Inc.
1607 S. Campus Ave., Ontario, CA 91761

Contact us by phone:
1-800-328-7363 (8:00am ~ 4:30pm PST)
or online <http://www.babytrend.com>

Close N Cozy Bassinet

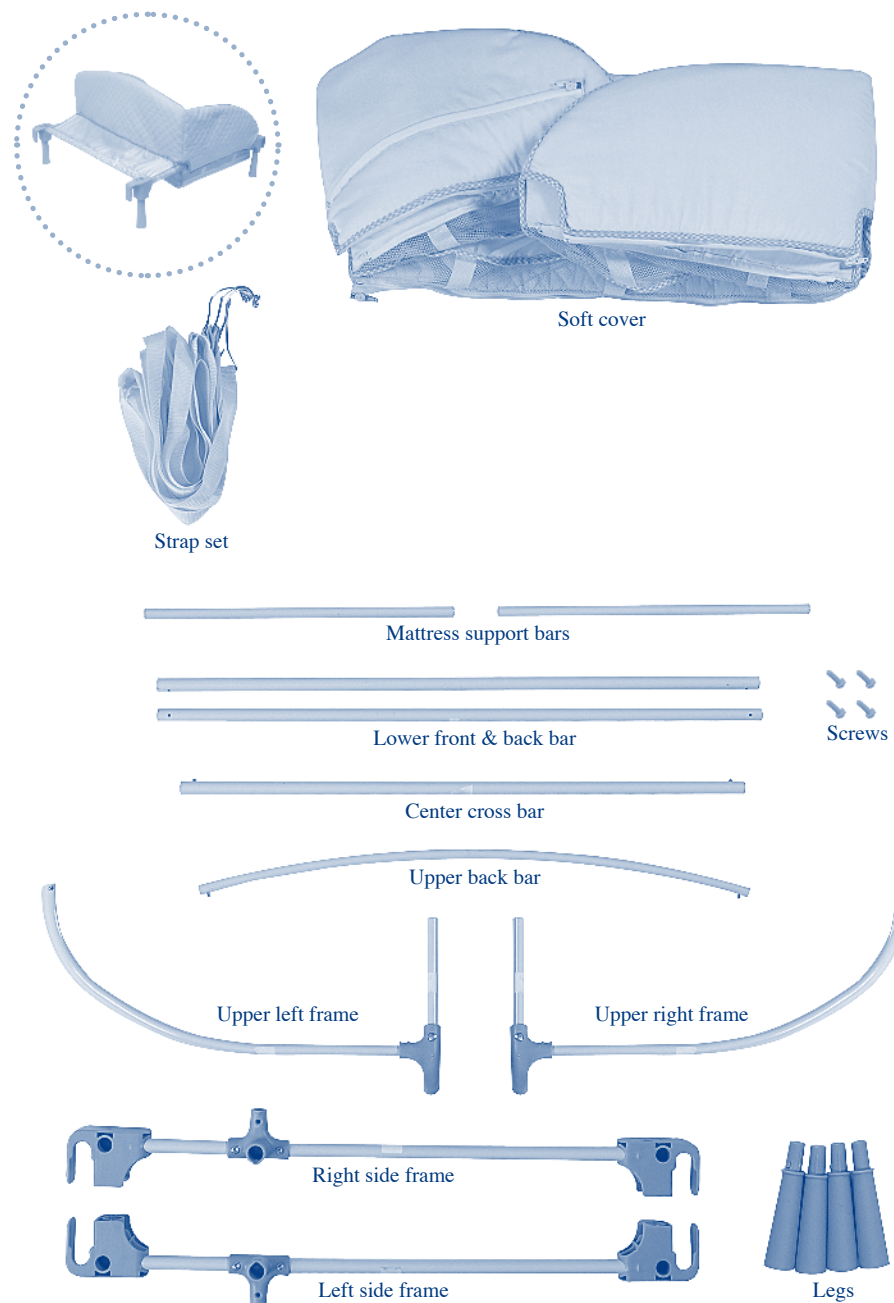

IMPORTANT! To ensure safe operation of your bassinet, please follow these instructions carefully. Please keep these instructions for future reference.

IMPORTANT! Before assembly and each use, inspect this product for damaged hardware, loose joints, missing parts or sharp edges. NEVER use if any parts are missing or broken.

IMPORTANT! Adult assembly is required.

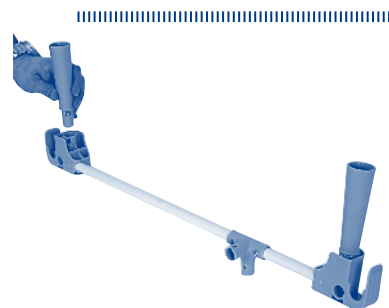

Fig. 34

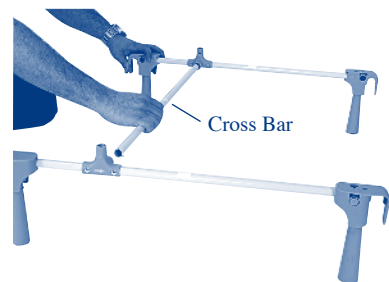

Fig. 35

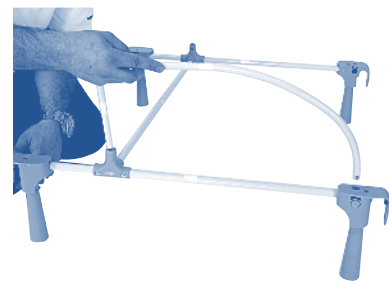

Fig. 36

TO ASSEMBLE Close N Cozy BASSINET

⚠ WARNING: This product must be fully assembled before use.

STEP 1:

Connect the LEGS (4ea.) to the side frame corners by inserting each leg into the round hole and pushing firmly into place. (Fig. 34) Check to make sure each leg is securely connected by pulling on it.

STEP 2:

Connect the center CROSS bar by lining up the two side frames and inserting each end of the bar into the housing. Line up snap-pins on all bars with the holes in the housing and “snap” into place. (Fig. 35)

IMPORTANT: Never loosely connect any parts of the frame.

STEP 3:

Connect the upper LEFT frame section to the left side frame by inserting the bars into the housing and frame corner as shown. The snap-pin on the curved bar should be facing outward. (Fig. 36) Repeat for the other side.

STEP 4:

Connect the upper BACK bar by lining up the snap-pins with the holes in the housings and insert into the upper left and right frame housings. (Fig. 37)

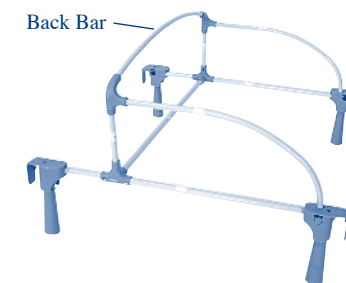

Fig. 37

STEP 5:

Soft Cover with Back Panel

Insert the lower BACK bar through the back panel of the soft cover as shown as Fig. 38.

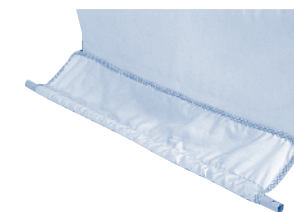

Fig. 38

STEP 6:

Slip soft cover onto and over frame. (Fig. 39)



Fig. 39

STEP 7:

Insert the lower FRONT bar through the round, padded sleeve on the front of the soft cover. (Fig. 40)

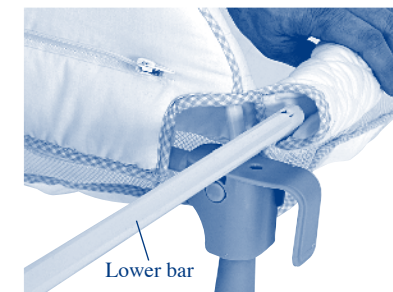

Fig. 40



Fig. 41

STEP 8:

Connect the lower BACK to the frame corners by slightly spreading the side frames and inserting the bar into holes. Then connect the lower FRONT bar. Secure the Front and Back Bar using the screws provided. (Fig. 41)

Note: The holes in the bar and the housing must line up in order to insert the screws and properly connect.



Fig. 42

STEP 9:

Connect the soft goods to the frame by turning the frame over and zipping closed all three (3) zippers.



Fig. 43

STEP 10:

Insert the mattress support bars by sliding one end of the bar through the pocket and back through the opposite side. (Fig. 42)

Note: Do not use this product without the support bars securely in place.



Fig. 44

STEP 11:

Insert mattress and position mattress in place. (Fig. 43) Using the full size playard mattress, fold in half and insert mattress with fastening strips facing front side of bassinet. Feed fastening strips through provided slots and secure the strips to velcro located on the bottom of the bassinet. (Fig. 44)

Your Close N Cozy bassinet is now ready to use.

⚠ FALL HAZARD: NEVER place Close N Cozy bassinet on an uneven or elevated surfaces.

⚠ WARNING: SUFFOCATION HAZARD: NEVER place pillows, quilts, comforters, sheepskins, pillow-like stuffed toys and other pillow like products in the Close N Cozy bassinet.

IMPORTANT! Cover infant with a thin covering, such as a crib blanket, receiving blanket or other blankets specifically designed for infants, only reaching as far as baby's chest, and tuck the covering around the mattress.

Attach Close N Cozy to playard

ATTENTION:

Before installing Close N Cozy bassinet, remove ALL accessories from playard. (Canopy, bassinet, changing table, mobile and music box.....)

Hold Close N Cozy bassinet over playard. Line up the frame corners over the top rails of the playard and push firmly downward. Make sure all four frame corners are attached to the playard's top rails (Fig. 45).



Fig. 45

IMPORTANT! Never use this product without the anchor buckle attached and locked as shown. Failure to use this anchoring system could result in serious injury or death to the infant. Make sure all straps are secured and tight. Check straps before each use.

IMPORTANT! Failure to use this securing system will allow Close N Cozy to move away from adult bed and could result in infant falling out.

IMPORTANT! NEVER leave infant unattended.

ATTENTION: Before attaching Close N Cozy to playard, you must

1. Playard, including side rails, must be fully erected prior to use. **Make sure latches are secure.** Refer to playard's instruction for details.
2. Determine the height of adult bed first. Place a flat object on the top of the adult bed (including base, springs and mattress) so that a few inches of it pass over the edge of the adult bed. Measure down from this point to the floor to find the exact bed height. It is recommended to use this feature with an adult bed with floor height 24" to 30".

Attach playard w/ Close N Cozy to bed

⚠ WARNING:
STRANGULATION / SUFFOCATION HAZARD:
The top rail of the playard must be at or below the top of the adult bed mattress when used with Close N Cozy.

⚠ WARNING:
STRANGULATION HAZARD:
When anchor buckle and strap assembly is not in use, store in a safe place not accessible to children.

1. Separate mattress from box spring.
2. Position Playard on the desired side of the bed.
3. With hooks positioned on the same side of the playard (Fig. 46), layout one strap set UNDER the bed frame and the other strap set ON TOP of the box spring. Fully extend both straps to the opposite side of the bed. (Fig. 47)



Fig. 46



Fig. 47

4. Attach the strap hooks to the playard legs by hooking the straps to their corresponding upper and lower positions at the front of the playard. (Fig. 48) To tighten the strap hooks, use the adjustment buckle and make sure the strap hooks stay in place while completing steps 5, 6, and 7.



Fig. 48

5. Connect the upper and lower strap sets at the opposite end of the bed by fastening the anchor buckle. (Fig. 49)
6. Position playard against the edge of the bed.
7. Secure playard against the side of the bed by tightening the straps as tight as possible. The playard must be securely positioned against the bed before use.

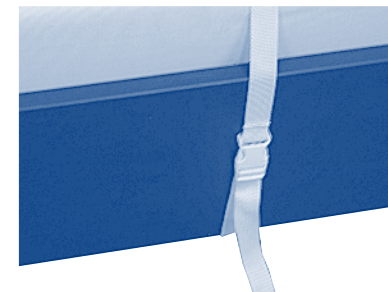

Fig. 49

Note: Set brake on Playard Wheels by pressing downward on the brake levers.

Important: Never use the Close N Cozy feature without the playard securely fastened to the bed.

8. Place mattress back onto box spring.

Your playard with Close N Cozy feature is now ready to use.